

IEEE

October / Octobre 2007, No. 55

Canadian Review

La revue canadienne de l'IEEE

Wireless

Handheld  Application Development

 System Design and Performance Analysis

Book Review: Next Generation  Systems & Networks



Canada Post—Canadian Publications Mail Sales
Product Agreement # 40592512



IEEE Canada



The Institute of Electrical and Electronics Engineers Inc.

IEEE Canada

Officers

Director/President - Robert Hanna
Director/President Elect - Ferial El-Hawary
Past Director/President - W.O.(Bill) Kennedy
Secretary - Vijay K. Sood
Treasurer - Rob Anderson
Director Emeritus - Wally Read
Director Emeritus - Ray Findlay

Groups & Committees

External Relations: Bruno DiStefano
Educational Activities - Saman Adham
Industry Relations - Bin Wu
Other Societies - Branislav Djokic
Professional Develop. - Bruno DiStefano
Sections/Chapters Suppt. - Gerard Dunphy
Member Services: Lori Hogan
Advancement - Kostas Plataniotis
GOLD - Lori Hogan
Life Members - Ron Potts
Membership Develop. - Elmer Bourque
Students - Janet Bradley
Women in Engineering - Jennifer Jessop
Publications & Communications: Om Malik
Canadian Review - Eric Holdrinet
CJECE - W.Kinsner & X.Maldague
Electr. Newsletter - Alex Bot
Publicity & Advertising - John Grefford
Translation - Christian P  pin
Webmaster - Ahsan Upal
Student Representative - Randy Glenn
Other Committees
Awards & Recognition - Robert Alden
Conference Advisory - Ashfaq Husain
Standards - Bill Lockley

Area Chairs

Canada Central: Keith Brown
Canada East: Amir Aghdam
Canada West: Lawrence Whitby

Section Chairs

Canadian Atlantic - Scott Melvin
Hamilton - Chris Maryan
Kingston - Keyvan Hashtrudi-Zaad
Kitchener/Waterloo - Shahab Ardalan
London - Maike Luiken
Montr  al - Anader Benyamin
New Brunswick - Luichen Chang
Newfoundland & Labrador - Kathleen Chafe
Ottawa - Wahab Almuhtadi
Peterborough - Sean Dunne
Qu  bec - Andr   Morin
North Saskatchewan - Denard Lynch
Northern Canada - James Brown
Saint Maurice - Christian P  pin
South Saskatchewan - Raman Paranjape
Southern Alberta - Philip Choy
Toronto - Alagan Anpalagan
Vancouver - Rasvan Mihai
Victoria - David Gregson
Winnipeg - Stephen Dueck

IEEE Canada Administrator

Cathie Lowell

IEEE Canadian Review General Information

The *IEEE Canadian Review* is published 3 times/year as follows: Spring (to appear in April-May), Summer (to appear in August-September), and Fall (to appear in December). Its principal objective is to project an image of the Canadian electrical, electronics, communications and computer engineering professions and their associated academic and business communities to:

- (i) Canadian members of IEEE;
- (ii) Canadian members of the profession and community who are non-members of IEEE;
- (iii) The associated Canadian academic (i.e. universities, colleges, secondary schools), government and business communities.

To ensure that the *IEEE Canadian Review* has the desired breadth and depth, editors are responsible for screening articles submitted according to the following general themes:

- | | | |
|--------------------------|-------------------|-----------------|
| 1- National Affairs | 4- Education | 7- Computers |
| 2- International Affairs | 5- Power | 8 - Electronics |
| 3- Industry | 6- Communications | |

Advertising Policy

Organizations are invited to place corporate advertising in the *IEEE Canadian Review*. For information regarding rates and copy requirements, please contact the Advertising Manager.

Circulation

The circulation of the *IEEE Canadian Review* is the entire membership of IEEE Canada, plus external subscribers.

Information for Authors

Authors are invited to contribute submissions in electronic form to the *IEEE Canadian Review*. Please contact one of the editors. Responsibility for the content rests upon the authors and not the IEEE, or its members.

Annual Subscription Price

Free of charge to all IEEE members in Canada. For IEEE members outside Canada: \$20.00/year. Non-members: \$35.00/year. Corporations and libraries: \$37.50/year. Additional copies may be ordered at a cost of \$7.50 each from the Managing Editor.

Reprint Permission

Abstracting is permitted with credit to the source. Libraries are permitted to photocopy for private use of patrons. Instructors are permitted to photocopy isolated articles for non-commercial classroom use without fee. For other copying, reprint or republication, please write to the Managing Editor. The *IEEE Canadian Review* is printed in Canada, postage paid at Toronto, (Ontario).

Change of address

- Do-it-yourself with MyIEEE: <http://www.ieee.org/myieee>
- Email: address.change@ieee.org
- Tel: 1 (800) 678-4333
- Mail: IEEE Service Center
445 Hoes Lane, P.O. Box 1331
Piscataway, NJ 08855-1331, USA

Managing Editor R  dacteur en chef

Eric Holdrinet
Consulat g  n  ral du Canada    L.A.
550 S. Hope Str., 9th Floor
Los-Angeles, CA 90405, USA
tel: (213) 346-2758
fax: (213) 346-2767
e.holdrinet@ieee.org

Associate Editors Adjoints    la r  daction

Alexandre Abecassis
Fasken Martineau DuMoulin

Habib Hamam
Universit   de Moncton

Khelifa Hettak
Communications Research Centre

Dave Kemp
Past-President, IEEE Canada

Terrance J. Malkinson
GE Capital ITS Inc.

Samuel Pierre
  cole Polytechnique de Montr  al

Camille-Alain Rabbath
Defence Research & Dev. Canada

Vijay Sood
Hydro-Qu  bec IREQ

Bin Wu
Ryerson University

Alain Zarka
SEA-Network

Advertising Manager Resp. de la publicit  

John Grefford
1895 William Hodgins Lane
Carp, ON, Canada, K0A 1L0
tel: (613) 839-1108
fax: (613) 839-1406
Grefford@ieee.org

Art & Production

Communication Matters
tel: (416) 599-9229
fax: (416) 599-8718
production@CommunicationMatters.com



Member of / membre constituant de
Engineering Institute of Canada
I'Institut canadien des ing  nieurs

The National Library of Canada
ISSN 1481-2002
La Biblioth  que nationale du Canada

Eric Holdrinet SMIEEE, Rédacteur en chef / Managing Editor

La question suivante revient comme le rhume saisonnier: Quel devrait être le thème du prochain numéro de la Revue? Cela peut conduire à moult reniflements, frissons, voire un mal de tête dépendant de (disons) l'originalité des propositions. Mais après une semaine, du sommeil et beaucoup de liquide chaud, la situation se résoud généralement d'elle-même.

Le présent numéro est sur le **Sans fil** – moyen par lequel, à propos, de nombreux virus sont transmis; voir l'article « La sécurité dans les réseaux locaux sans fil » dans le dernier numéro. Nous aurions pu imprimer plus précisément « Systèmes sans fil », mais ça aurait manqué de mordant.

Deux articles sur le développement de systèmes sans fil nous proviennent de l'Université Ryerson (Ontario); je crois que c'est la première fois que nous avons du contenu de cette institution. Une revue du livre *Next Generation Wireless Systems and Networks* est fournie par l'Éditeur associé Dr. Hamam de l'Université de Moncton. Un autre membre de notre équipe, M. Abecassis, propose un papier sur les Brevets logiciels; les systèmes de télécommunications et sans fil ne sont-ils pas largement composés de logiciels de nos jours?

Un autre élément du présent numéro pourra attirer votre regard: Nous publions un article proposé par un dirigeant de compagnie sur cette dernière, « A Brief History of MPB Technologies Inc. » Est-ce de la publicité? Je ne crois pas – du moins pas plus qu'un article sur les succès techniques d'un labo universitaire ne polirait son image.

L'article a été sélectionné parce qu'il est à propos d'une compagnie canadienne qui a conçu des produits d'ingénierie innovateurs et hautement complexes, l'auteur est un IEEE Life Fellow respecté, il est bien écrit, "et parce que j'ai aimé l'article" (être rédacteur en chef comporte sa part de privilèges).

Idéalement, cet article n'aurait-il pas été écrit par un reporter IEEE? Absolument. Le poste est ouvert.



The following question comes back like seasonal cold: What should be the theme of the next Review issue? It can lead to sniffing, shivering, or the occasional headache depending on the—let's say—originality of proposals. But after about a week, some sleep and much hot drink, the situation usually resolves itself.

The current issue is on **Wireless**—which is, by the way, how many viruses get transmitted; see article “La sécurité dans les réseaux locaux sans fil” in the last issue. We could have printed more accurately “Wireless Systems Development”, but it would have had less punch.



Two articles about wireless systems development come from Ryerson University (Ontario); I believe it is the first time we have had contents from this institution. A review of the book *Next Generation Wireless Systems and Networks* is provided by Associate Editor Dr. Hamam from the University of Moncton. Another member of our team, Mr. Abecassis, proposes a column on Software Patents. Oh well, aren't telecommunications and wireless system largely made of software nowadays?

Another feature of the current Issue may catch your eye: We are publishing an article proposed by a business executive about his own company, “A Brief History of MPB Technologies Inc.” Is it advertisement? I don't think so—at least no more than an article about technology achievements at a university laboratory would burnish its image.

The article was selected because it is about a Canadian corporation which introduced innovation and highly complex engineering products, the author is a respected IEEE Life Fellow, it is well written, “and because I liked it” (Editorship hath its privilege).

Ideally, should such an article be written by an IEEE reporter? You bet. Positions still open.

Table of Contents / Table des matières

	<i>Page</i>
<i>News / Nouvelles</i>	
Editorial / Éditorial	3
Letter to Editor / Lettre envoyée au rédacteur	4
Director's Report / Rapport du Président	5
Region 7 Director-Elect Candidate Profiles	6
Canadian Newslog / Coupures de Presse Canadienne	8
A View from the West / Nouvelles de l'ouest	9
<i>Telecommunications / Télécommunications</i>	
Handheld Wireless Application Development	10
by Lourdu Joseph and Alagan Anpalagan	
Next Generation Wireless Systems (Book Review)	14
by Habib Hamam	
Wireless System Design & Performance Analysis	15
by Alexander Hamlyn and Alagan Anpalagan	
<i>History / Histoire</i>	
A Brief History of MPB Technologies Inc.	21
by Morrel Bachynski	
<i>Intellectual Property / Propriété Intellectuelle</i>	
Software Patents	24
by Alexandre Abecassis	
<i>Engineering Management / Gestion du génie</i>	
Engineering Management: What's New in the Literature?.....	28
by Terrance Malkinson	
<i>Community News / Nouvelles de la communauté</i>	
ICUE 2007 (Toronto) Report	29
by Vijay Sood and Dimitrios Androutsos	
<i>News / Nouvelles</i>	
CCECE '07 / CCGEI '07 Awards	30
Conferences: IEEE & Collaboration, in Canada, '07/'08.....	32

Paying Tribute to Reginald Fessenden

I was pleased to see a copy of my favorite photograph of Reginald Aubrey Fessenden, at his work desk smoking a cigar, with a pair of ear phones on his head, on the cover of the Spring 2007 issue of the IEEE Canadian review Magazine, and to read the few words you said about the 100th anniversary of the first wireless broadcast.

2006 was indeed the 100th anniversary of Reginald Aubrey Fessenden's greatest wireless communications experiments and successes, a culmination of his work which began a decade earlier:

- He was the first to use the word and method of continuous waves (circa 1897).
- He was the first to transmit voice over radio (December 1900).
- He devised a detector for continuous waves (circa 1902).
- He was the first to use the word and method heterodyne (circa 1902).
- He was the first to send two-way trans-Atlantic wireless telegraphy messages (circa January 1906), and the first to record the night-to-night variability of wireless transmission (propagation studies).
- He was the first to send wireless telephony (voice) across the Atlantic (circa November 1906).
- He was the first to demonstrate wireless telephony in practical use, ship-to-shore and shore-to-ship, between Brant Rock and a small fishing vessel equipped with wireless telephone 20 km out in Massachusetts Bay (circa 3 November 1906).
- He was first to discover evidence for long path as well as short path signals (fall 1906).
- He was the first to demonstrate wireless transmission in conjunction with wire lines (telephone-to-telephone via radio), 21 December 1906.
- He made the first wireless broadcast, voice and music, 24 December 1906, 31 December, 1906.

Fessenden is indeed the principal pioneer of radio as we know it today.

I have written a number of papers recalling his wireless inventions and communications achievements and countering published papers suggesting that his 1906 Christmas Eve Broadcast might not have been made. You can websearch them using the search string "John S. (Jack) Belrose on Fessenden".

While in recent years there has been a lot of interest in the history of wireless, and on what I have written about Fessenden, two achievements which have caught the attention of wireless historians are my simulation of the sounds of a spark gap transmitter [<http://www.hammondmuseumofradio.org/spark.html>], and more recently my simulation of his Christmas Eve Broadcast, made using an electro-mechanical HF alternator: "BBC 20 Minutes Another Salute to Radio" [<http://www.fessenden.ca/>] and [<http://www.hammondmuseumofradio.org/fessenden2006-recreation.html>].

This was an excellent program broadcast December 23, 2006 on BBC Radio 3. It includes an interview with me, and played my simulation of Fessenden's Christmas eve broadcast, produced technically as Fessenden did - using a Laboratory version of Fessenden's HF Alternator (a step-motor driven at 14,400 rpm to generate a frequency of 48 kHz) and a carbon microphone in series with our tuned simulated antenna. The recording was made perhaps just in time since the brushes on our DC motor (we should have had a brushless motor) were starting to wear out—listen and note a couple of hick-ups in the speed of the motor changed—and one can hear the high pitched whine (the mechanical sound) of the motor/step motor, even though the devices were in a separate room. But that is perhaps okay since it shows that we were indeed using a mechanical device.

For a detailed overview of wireless technologies during the first decade of 1900, see:

Belrose, J.S., "The Development of Wireless Telegraphy and Telephony, and Pioneering Attempts to Achieve Transatlantic Communications", Chapter 12, *History of Wireless*, pp. 349-420, editors Sarkar, Mailloux, Oliner, Salazar-Palma and Sengupta, John Wiley & Sons, 2006.

Preceding received from:

John S. (Jack) Belrose, PhD Cantab, VE2CV

- Radioscientist Emeritus, Communications Research Centre Canada
- Life Senior Member IEEE (Antennas and Propagation Society)
- Life Member Radio Club of America, Life Member Quarter Century Wireless Association
- Member Antique Wireless Association
- Technical Advisor ARRL

Editor's note:

The Canadian Review welcomes all your observations about the stories we cover. If you can think of other such Canadians whose contributions to our profession have gone unsung, sent us a note, and we'll try to include a summary of their work in a future issue.



A little more than 100 years ago, on Christmas eve of 1906, the great Canadian inventor Reginald Aubrey Fessenden transmitted what has been recognized since as the first radio program. It included two musical selections, a poem, and a short talk. This was an immense progress compared to the spark-based, Morse-code carrying wireless transmissions then in use, and it would still take years for this innovation to be recognized and adopted.

Fessenden's work on voice radio was emblematic of a spectacular increase in the bandwidth of the medium, with repercussions that continue to this day in business, research and society at large.

(Excerpted from Editorial, CR54)

Bob Hanna, President of IEEE Canada: 2006-2007 / Président de l'IEEE Canada: 2006-2007

I am pleased to report that our 20th annual IEEE Canadian Conference on Electrical and Computer Engineering (CCECE 07) which took place April 22-25, 2007 in Vancouver was a great success, judging by the impressive technical program and number of attendees. The conference was founded in 1987 by Prof. Vijay Bhargava and his dedicated team and we are very grateful for their tireless efforts in organizing this conference again in Vancouver (<http://iee.ca/ccece07>). One of the key highlights of the conference was our traditional Monday banquet, where IEEE Canada presented awards to distinguished members for their technical achievements and extraordinary services (<http://ewh.ieee.org/reg/7/awards>). The CCECE 08 will take place in Niagara Falls, May 04 - 07, 2008 (<http://iee.ca/ccece08/>)

On September 13-16, 2007, the IEEE Canada executive committee will be meeting in Edmonton to review our work plan and budget for 2008. This meeting will take place in conjunction with our annual student workshop and the third annual TELUS innovation competition. Nine universities have been pre-selected and will compete in presenting their projects in front of a panel of judges for a top prize of \$10,000. IEEE Canada is very grateful to TELUS for their support of our students.

IEEE Canada, in collaboration with Montreal and Ottawa sections, is organizing the first Electrical Power Conference (EPC), to take place October 25-26, 2007 in Montreal (<http://www.ieee.ca/epc07>). The theme of this conference is "Renewable and Alternative Energy Resources". This conference is an extension/spin-off of the Electrical Power Symposia (EPS) that started in Ottawa and for the past six consecutive years were successfully organized by the IEEE Ottawa Section. We are very grateful to Dr. Vijay Sood and his team in organizing this year's event.

For the first time, our Education committee held a webinar on April 10, 2007; the topic was "Developing Leadership Skills". Some 125 members participated in this seminar. Based on this success, we are planning to hold two more webinars before year end. We are grateful to Celia Desmond (IEEE Canada President 2000-2001) for her excellent presentation and Dr. Saman Adham, chair of Education Activities, for organizing the webinar.

In 2006/2007, the IEEE Regional Activity Board (RAB) has undertaken a major review to improve the way we serve our members. A committee has been working on this project and has made several progress presentations to the IEEE Board of Directors. When fully transformed by the end of the year, it will be called the "Member and Geographic Activities Board", or MGA.

IEEE Canada and the Quebec Section are working together to host the 2008 IEEE Section Congress (SC). This event takes place every three years and delegates from all 10 regions, including chairs of 310 sections, will be participating. This major event will take place October 19-22, 2008 in Quebec City. The theme for this 2008 SC is "Celebrating Volunteer Achievements Worldwide", (<http://www.ieee.org/web/volunteers/sections-congress>). We are very pleased that for the first time, the 2008 IEEE Honours Ceremony will take place during the 2008 SC. The ceremony highlights the accomplishments of IEEE Award and Medal recipients of that year.

I am very grateful to all our volunteers in IEEE Canada, who work hard to serve our members across this beautiful country.



Vijay Bhargava welcomes CCECE 2007 attendees to the Awards Ceremonies, a highlight of the conference.

Vijay Bhargava accueille les délégués du CCGEI à la cérémonie de remise des prix, un point fort de la conférence.

J e suis heureux de vous informer que notre 20ième conférence canadienne annuelle de l'IEEE en génie électrique et informatique (CCGEI 07) qui a eu lieu du 22-25 avril 2007 à Vancouver, a été un grand succès à en juger par le programme technique impressionnant et le nombre de participants. La conférence a été initiée pour la première fois en 1987 par le professeur Vijay Bhargava et son équipe dédiée, et nous sommes très reconnaissants pour leurs efforts inlassables dans l'organisation de cette conférence qui se tenait cette fois encore à Vancouver (<http://iee.ca/ccece07>). Un des points culminants de la conférence fut notre banquet traditionnel du lundi, où IEEE Canada a présenté les prix aux membres distingués pour leurs accomplissements techniques et services rendus (<http://ewh.ieee.org/reg/7/prix>). Le CCGEI 08 aura lieu à Niagara Falls du 4 au 7 mai 2008 (<http://iee.ca/ccece08>).

Du 13 au 16 septembre 2007, le comité exécutif de l'IEEE Canada se réunira à Edmonton pour passer en revue notre plan de travail et notre budget pour 2008. Cette réunion aura lieu en même temps que notre atelier étudiant annuel et la troisième compétition d'innovation annuelle de TELUS. Neuf universités ont été pré-sélectionnées et seront en compétition en présentant leurs projets devant un jury, ceci dans le but de remporter un premier prix de \$10 000. IEEE Canada est très reconnaissant envers TELUS pour leur appui envers nos étudiants.

IEEE Canada en collaboration avec les sections de Montréal et d'Ottawa, organise la première conférence sur l'énergie électrique (EPC), qui aura lieu du 25 au 26 octobre 2007 à Montréal (<http://www.ieee.ca/epc07>). Le thème de cette conférence est "Sources d'énergies renouvelables et alternatives". Elle est une extension des colloques sur l'énergie électrique (EPS) organisés avec succès par la section d'Ottawa de l'IEEE au cours des six dernières années. Nous sommes très reconnaissants à Dr. Vijay Sood et son équipe pour l'organisation de l'événement de cette année.

Pour la première fois, notre comité d'éducation a tenu un webinaire le 10 avril 2007, dont le sujet était "Le développement des habiletés de Leadership". Environ 125 membres ont participé à ce séminaire. Basé sur ce succès, nous projetons tenir deux webinaires supplémentaires avant la fin de l'année. Nous sommes reconnaissants envers Celia Desmond (Présidente IEEE Canada 2000-2001) pour son excellente présentation, et Dr. Saman Adham, Président des Activités d'éducation, pour l'organisation du webinaire.

En 2006/2007, le Bureau des activités régionales de l'IEEE (RAB) a entrepris une importante revue afin d'améliorer la façon de servir nos membres. Un comité avait travaillé sur ce projet et avait fait plusieurs présentations d'état d'avancement au conseil des directeurs de l'IEEE. Lorsqu'il sera entièrement transformé d'ici la fin de l'année, celui-ci s'appellera le "Member and Geographic Activities Board", ou MGA.

IEEE Canada et la section de Québec travaillent ensemble pour accueillir le congrès des sections de l'IEEE (SC) de 2008. Cet événement a lieu tous les trois ans et les délégués de chacune des 10 régions, incluant les présidents de 310 sections, y participeront. Cet événement majeur aura lieu du 19 au 22 octobre 2008 dans la ville de Québec. Le thème sera "Célébrons les accomplissements des volontaires dans le monde entier" (<http://www.ieee.org/web/volunteers/sections-congress>). Nous sommes très heureux que pour la première fois la Cérémonie d'honneur de l'IEEE 2008 aura lieu pendant le SC. La cérémonie soulignera les accomplissements des récipiendaires de prix et de médailles de l'IEEE de l'année.

Je suis très reconnaissant envers tous nos volontaires au sein de IEEE Canada, qui travaillent fort afin de servir nos membres à travers ce beau pays.



Bob Hanna, P.Eng., FIEEE, FEIC, FIEE
r.hanna@iee.org

Candidates for Region 7 Director-Elect, 2008-2009



Robert L. Anderson,
(Nominated by Region 7)
Principal,
SIMMARIX Inc., Calgary
rlanderson@ieec.org
<http://members.shaw.ca/rlaieec>

I am honoured to be considered for the position of Director Elect and Director for IEEE Canada. Since becoming an active volunteer in IEEE, the organization has faced many challenges and changes. The biggest challenge currently facing IEEE is its membership base. IEEE Canada must continue to explore ways to attract new membership and retain existing members. IEEE Canada has spent a number of years developing a solid financial model — this task is now complete and the next task for IEEE Canada is expanding its membership.

Members and non-members need to perceive a value in belonging to IEEE. To accomplish this goal within IEEE, IEEE Canada needs to deliver this message to members and potential members within our geographic boundaries.

This can be achieved through the following:

- Carry out a review of the Region's current service offerings to its members to ensure they are delivered as efficiently and effectively as they can be.
- Expand IEEE Canada ties with other technical and non-technical societies, and perhaps reviewing of existing affiliations to better benefit IEEE.
- Strengthen the Region's ties with other IEEE entities (sections, chapters and technical societies) by co-sponsoring or developing activities at the local level. By increasing the visibility of IEEE, IEEE Canada gets another opportunity to market the value of membership. This is not an easy task and can only be accomplished if we all as volunteers consider the time constraints on us *as volunteers*.

In summary, I will work tirelessly to ensure that services and products offered by IEEE Canada provide maximum value to our membership and are marketed appropriately to potential members. Please contact me electronically or at 403-681-7407 to discuss any of the above.

Rob is part owner of a business and management consulting firm in Calgary, SIMMARIX Inc. Rob is the Director of Market Development where he uses his knowledge of the energy and technology industries to seek out and develop prospective business opportunities.

Prior to joining SIMMARIX, Rob worked for ENMAX Corporation, the electric utility for his home city of Calgary. During his eleven-year career with ENMAX Corporation, Rob held a variety of positions in management, customer service, engineering and contracts management.



Om P. Malek
(Nominated by Region 7)
Professor Emeritus,
Dept. of Electrical &
Computer Engineering,
University of Calgary
maliko@ieec.org

It is an honour to be nominated for Delegate/Director-Elect for Region 7 (Canada). With more than 35 years of involvement from the Section to the IEEE Board Committee level, I have gained a broad knowledge of IEEE that I hope will help me do the job well.

No individual is an island unto self. Success can only be achieved working as a group. IEEE has a vast pool of talent in its members. A challenge to those who lead the organization at any time is to rally and pool that talent to address important problems. I hope to draw on the talent and knowledge of many of the IEEE members. I will facilitate their efforts by providing all my support and encouragement.

As Region Director, my primary goals will be to:

- Run programs in the most efficient and cost effective way so as to deliver quality and value.
- Facilitate efforts at all levels in the Region to encourage growth in membership.
- Encourage closer relationships between Sections, Chapters and their student branches for increased retention of graduating student members.
- Become more responsive to the needs of our diverse membership.
- Improve existing services and introduce new programs which will benefit our members.
- Emphasize the needs of our unique situation as a one-country Region.

I solicit your opinion by e-mail, by phone (403-220-6718) or mail, and your vote.

Om Malik is currently Professor Emeritus, University of Calgary. He began his career working as an engineer at the Punjab State Electricity Board, India, from 1953 to 1961. He then pursued advanced academic studies, including NDEE, Delhi Polytechnic, India, 1952; M.E., University of Roorkee, India, 1962; Ph.D., University of London, U.K., 1965; and, DIC, Imperial College, London, U.K., 1965.

In 1965 Dr. Malek came to Canada where he became Assistant Professor at University of Windsor, Canada, 1966-68. He then became Professor at the University of Calgary, 1968-1997. In 1997 he became Professor Emeritus, Schulich School of Engineering, Department of Electrical & Computer Engineering, University of Calgary.



Hilmi M. Turanli
(Nominated by Region 7)
Interconnections and Grid
Supply Studies Engineer,
Manitoba Hydro
hturanli@ieec.org
<http://www.mts.net/~joanald/>

I accept the nomination of candidacy for IEEE Region 7 Director (IEEE Canada President) with great honour, and thank those who trust in me and nominated me for the position this year. Since 1999, I have been active in various Region activities, specifically Finance, Treasurer, Conferences and Membership Development. As Director, I will use my experience and understanding to provide down-to-earth direction as we embark on relationships designed to improve member benefits, professional development, and education at all levels within academia and industry in Canada.

In addition, I will promote increased participation between Areas, Sections and Chapters in order to learn good practices and experiences from each other. My objectives include:

- Exposing a broader range of IEEE resources including technical, professional and soft skills to our Sections and Members.
- Getting more members active in Chapters, Sections and the Region.
- Exploring other avenues, such as advertising, job sites, on-line courses and IEEE TV to serve our members better.
- Developing increased recognition of Section leaders and volunteers.

I will encourage improvements in areas such as Financial Advantage, IEEE and EIC job sites, especially for Regions 7- 10 where some of today's programs do not apply yet. This is the area of our strongest membership growth. I will strive to develop methods that facilitate IEEE becoming truly transnational and facilitate communication between members and organizational units within IEEE.

I would provide the necessary leadership as the IEEE Region 7 Director (IEEE Canada President) and propose and support prudent policies to the IEEE Regional Activities Board. I have the education, experience and integrity to serve as Region 7 Director and I will be an asset for the Institute.

In 1986, Dr. Turanli started working for Manitoba Hydro as a Computer Applications Engineer, and later as an HVDC Planning Engineer for a number of years. His current industry position is Interconnections and Grid Supply Studies Engineer at Manitoba Hydro. He is/was involved on a number of committees and working groups at Mid-Continent Area Power Pool and Midwest Reliability Organization headquartered in Minneapolis, Minnesota. He is also Adjunct Professor at the Department of Electrical & Computer Engineering, University of Manitoba.

Robert L. Anderson

IEEE Activities

(S'88-S'91-M'91-SM'99)

COMMITTEES/BOARDS

RAB MDC (Membership Development Committee), 2000-03; RAB Finance Committee, Member, 2004.

REGIONS

Treasurer, 2004-2007, IEEE Canada (Region 7); IEEE Canada Web Page Competition, Judge, 2004; Membership Development Chair, 2000-2003; Region 7 Sections Congress Coordinator, 2002; Chair Electronic Services Review Committee, 2001; Member IEEE Canada Audit Committee, 1997.

COUNCILS

Western Canada Council: Treasurer, 1999; Membership Development Committee, 1999.

SECTIONS/CHAPTERS

Southern Alberta Section Chair, 1997-2000; Vice Chair, 1996-97. Power Engineering and Industry Applications Joint Chapter, Chapter Chair, 1994-95.

Other IEEE Accomplishments

In addition, Mr. Anderson has carried out the following activities for IEEE Canada:

1. One of three Auditors to perform the 1993 IEEE Canada peer Audit of finances and operations.
2. Reinstated the peer-Audit committee after a 12-year hiatus to review record keeping processes and principles.
3. Started an Investment Policy Committee, one goal of which is to ensure the Region's operating reserve policy is sound and current.
4. Led a value-for-money audit on IEEE Canada Electronic Services which eliminated duplicated services from IEEE Headquarters and reduced operational costs to IEEE Canada.
5. Started an IEEE Canada Treasurer's Handbook which contains the Region's financial operational policies.

Outside of work, Rob actively supports his profession. He has spoken to first-year engineering students at the University of Calgary regarding careers in engineering. He has participated as a judge for student projects/paper competitions on a regular basis.

AWARDS

IEEE Millennium Medal, 2000; IEEE Western Canada Council Ted Glass Merit Award, 2004.

Om P. Malek

IEEE Activities

(M'1966-SM'1969-F'1987-LF'2000)

COMMITTEES/BOARDS

RAB Student Activities Committee, Member, 1978-80; Fellows Committee, Member, 1998-2001; Member Conduct Committee Hearing Panel, Member, 2000-02, 2004-06; Life Members Committee, Member, 2002-07; Chair, 2004-05.

REGIONS

Region 7: Secretary, 1998-2000; Region Board, Member, 1973-74, 1978-80, 1983-84, 1998-2002, 2004-07; Region Executive, Member, 1978-80, 1983-84, 1998-2002, 2004-07; Publications and Communications Group, Chair, 2005-07; Projects Ranking Committee Chair, 1998-2000; Nominations and Appointments Committee, Member, 2001-04; Awards Committee, Member, 1984-90; Student Activities Committee, Member, 1977-78, Chair, 1978-80; Educational Activities, Vice-Chair, 1987; Canadian Journal of Electrical and Computer Engineering, Associate Editor, 1988-97, Editor, 1998-2002; Canadian Conference on Electrical and Computer Engineering, Program Committee Member, 1994, 1996, 1999, 2005; Organizing Committee Chair, 1996.

COUNCILS

Western Canada Council: Member, 1973-74, 1976-77; 1983-90, 2001-04; Chair, 1983-84; Tour Program Coordinator, 1976-77; Awards Committee Chair, 1984-90; Nominations Committee, Chair, 2001-04.

SECTIONS

Southern Alberta: Executive Committee, Member, 1971-74, 1976-79; Program Chair, 1971-72; Vice-Chair, 1972-73; Chair, 1973-74; Educational Activities Committee, Chair, 1976-84; Student Activities Committee, Chair, 1976-78; Nominations Committee, Member, 2006.

CONFERENCES

Canadian Conference on Electrical and Computer Engineering; Organizing Committee, Chair, 1996; Program Committee Member, 1994, 1996, 1999, 2005.

AWARDS

Centennial Medal, 1984; Millennium Medal, 2000; Region 7; General AGL McNaughton Medal, 2001; WCC Merit Award, 1986; Power Engineering Society Recognized as Significant Reviewer, 2006.

Hilmi M. Turanli

IEEE Activities

(S'81-M'84-SM'98)

COMMITTEES/BOARDS

RAB (Regional Activities Board), 2006-07; RAB Vice Chair - Member Activities, 2006-07; RAB Enterprise Engineering Project AdHoc Committee, 2006; RAB FinCom (Finance Committee), 2006-07; RAB ARC (Awards Recognitions Committee), 2006-07; RAB MDC (Membership Development Committee), 2006-07; Tellers Committee, 2007 (withdrawn for election), RAB FinCom, Corresponding Member, 1999-2003.

REGIONS

Region 7: Regional Board, 1999-2005; Executive Committee; 1999-2005; Member Services Group Chair, 2005; Membership Development Chair, 2004-2005; Treasurer, 1999-2003; CONAC (Conference Advisory Committee) Member, 1999-2003.

SECTIONS/CHAPTERS

Winnipeg Section Chair, 1999-2000; Vice Chair, 1998-99; Treasurer, Secretary 1997-98; 1996-97; Professional Activities Chair, 2000-07; PES Winnipeg Chapter, Past Chairman, 1991-92; Chairman, 1990-91; Secretary/Treasurer, 1989-90.

STUDENT BRANCHES

Univ. of Manitoba Student Branch, 1981-83.

CONFERENCES

Conference Treasurer, Canadian Conference on Electrical and Computer Engineering (CCECE) Winnipeg, MB, Canada, 2002; CCECE'02 Executive Committee 2000-02; Invited speaker, Canadian Conference on Computer and Software Engineering Education, University of Manitoba (Drake Centre), 2002; Invited Panelist, Preparing for the Next Generation at Manitoba Hydro, IEEE PES 2001 Summer Meeting, Energy Development and Power Generation Committee, Panel Session, Harnessing Untapped Hydro Power Worldwide, Vancouver, B. C., July 2001.

SOCIETIES

Power Engineering Society (PES), 1985-1993, 2002-07; PES Author/Reviewer 1985-87

AWARDS

Section Award for Outstanding Contributions to the Growth of the IEEE Winnipeg Section, 2000; Fellow, Engineering Institute of Canada, 2001; Edward F. Glass Merit Award, IEEE Canada, 2006.

Candidates' Statements and CVs are also available at <http://iee.ca/candidates>



VOTE NOW!

<https://www.directvote.net/iee>



Alexandre Abecassis is a patent agent and Partner at Fasken Martineau DuMoulin LLP, Lawyers and Patent and Trade-mark Agents.

Alexandre Abecassis est agent de brevet associé chez Fasken Martineau DuMoulin S.E.N.C.R.L., s.r.l., Avocats et agent de brevets et de marques de commerce.

Send any news clippings you would like to contribute via e-mail to alexandre.abecassis@ieee.org

Veillez faire parvenir les coupures de presse proposées par e-mail à alexandre.abecassis@ieee.org

MONTREAL, QC. 23 Août 2007. Miranda Technologies a lancé une nouvelle version de sa plateforme d'écrans multi-images de dernière génération Kaleido-X™. Cette version prend en les signaux audio et vidéo ainsi que les métadonnées

pour les malentendants et pour les suivi des cotes d'écoutes. Ceci est effectué sans interruptions de transmission.

MONTREAL, QC. Jul. 25, 2007. Dialogic announced that it is the recipient of the Frost & Sullivan Market Global Excellence Award. Frost & Sullivan, a global growth consulting company, has presented this award to Dialogic in honor of its accomplishments in the global enabling technology market.

MONTREAL, QC. Jun. 19, 2007. Redback networks, an Ericsson company that provides video-centric routers for 75% of the world's largest triple-play networks, announced that Jianguo Telecom, an independently-run subsidiary of China Telecom, has deployed its multi-service edge routing platform for IPTV, broadband-on-demand and other triple-play services. Such a service generally refers to the providing of high-speed Internet access, television, and telephone over a single broadband connection. Jianguo Telecom is one of the largest provincial telecom operators of China Telecom and serves more than 3.3 million broadband subscribers.

QUÉBEC, QC. 16 mai 2007. La Commission de la Santé et Sécurité au Travail du Québec (CSST -

Commission of Occupational Health / Workers' Compensation Board) a sélectionné Loran Technologies et son partenaire Unisys Canada comme fournisseurs de technologies pour son plan de rationalisation de l'arbitrage et de la gestion des demande d'indemnisation des travailleurs. La Commission traite environ 300 000 demandes d'indemnisation par année.

OTTAWA, ON. Sept. 11, 2007. March Networks, a provider of IP video and business analysis applications announced that the Mexican bank Banco del Bajío has selected its digital video software and systems for more than 140 banking branches throughout Mexico.

MONTREAL, QC. Aug. 27, 2007. Nstein announced that one of its products has been selected by the U.S. trade publication KMWorld as one of its "Trend-Setting Products of 2007". The list identifies key products that have had an impact on the market over the past year; it is compiled by KMWorld editors based on discussions with knowledge management practitioners, integrators, analysts and end-users.

TORONTO, ON. May 7, 2007. Musicrypt announced that it has recently asserted its intellectual property rights in Canada by advising certain Canadian users of Destiny Media Technologies' Play MPE™ that there is serious patent litigation in progress regarding the use of Play MPE™ in Canada, and that such use may constitute infringement of Musicrypt's Canadian patent No.2,407,774. In fact, Musicrypt and Destiny have been involved in a court action in the Federal Court of Canada in respect of Musicrypt's patent since March 2006 and Musicrypt believes that its patent is valid and has been infringed by Destiny. Musicrypt claims \$15 million in damages.

VICTORIA, BC. Apr. 16, 2007. The government of British Columbia has selected Sun Microsystems and a consortium of partners to develop and implement an electronic healthcare solution that will transform the way laboratory results and other patient information is securely shared amongst healthcare practitioners across the province. The systems will provide faster access to patient information, reducing wait times for procedures and saving healthcare costs by reducing the occurrence of re-tests. In collaboration with the B.C. provincial government, Sun will design and build the Provincial Laboratory Information Solution and the interoperable Electronic Health Record system.

OTTAWA, ON. Apr. 10, 2007. QNX software system has received the "Technology Partnership Award" from the Ottawa Centre for Research and Innovation (OCRI) for its QNX and Intel Multi-Core Expedite Program.

SCARBOROUGH, ON. Apr. 3, 2007. The Ontario government is donating 500 desktop personal computers to Ontario schools through the Computers for Schools program run by Renewed Computer Technology (RCT). The computers are donated by the Ontario Ministry of Training, Colleges and Universities from a surplus resulting from the transfer of seven federal government training programs to Employment Ontario in January 2007. Employment Ontario is Ontario's employment and training network

MARKHAM, ON. Mar. 28, 2007. Nightingale Informatix Corporation, a healthcare application service provider (ASP) of Electronic Medical Record (EMR) and Practice Management software, has announced that it has signed an agreement with MCI Medical Clinics, one of the largest chains of outpatient clinics in Canada, to provide its healthcare software solutions to 20 MCI clinics.

OTTAWA, ON. Jun. 27, 2007. Mitel Networks Corporation, a provider of unified IP communications solutions and applications, has announced that it has filed a lawsuit against ShoreTel Inc. in the U.S. District Court for the Eastern District of Texas, alleging infringement of U.S. Patent Nos. 5,940,834, 5,703,942, 5,541,983, and 5,657,446.

TORONTO, ON. May 3, 2007. The Swiss bank Pictet & Cie will receive a 3D facial recognition system based on Bioscrypt technology. The system directs structured invisible light onto a subject's face to create a facial grid of 40,000 measurable data points. The system performs multiple facial scans and comparisons against a database of stored images and corresponding data, performing accurate identification at sub-second speeds, from which authorized persons are confirmed for access.

MONTREAL, QC. Mar. 28, 2007. CAE has celebrated today 60 years of innovations and at the same time has launched a new product which addresses training requirements for high-volumes commercial narrow-body aircraft such as the Boeing 737 and the Airbus 320 as well as the business jet market including the new business of Very Light Jets.

When you plan your next media budget ...

Don't give us a second thought.

Think of us first.

When you advertise in the IEEE Canadian Review you reach 15,000 of the industry's brightest and best, from coast to coast. People engaged in their profession, people who make things happen. Now that's something to think about.

For rates and deadlines contact:
John Grefford
 tel: (613) 839-1108
 fax: (613) 839-1406
Grefford@ieee.org

A View from the West

On: Prince Rupert (BC), Mining BC, Nuclear for Oil, Nutraceuticals for Colds, Greenjacket, Green China, Canadian Smarts, Big and Growing Businesses

By Terrance Malkinson
 Senator, University of Calgary

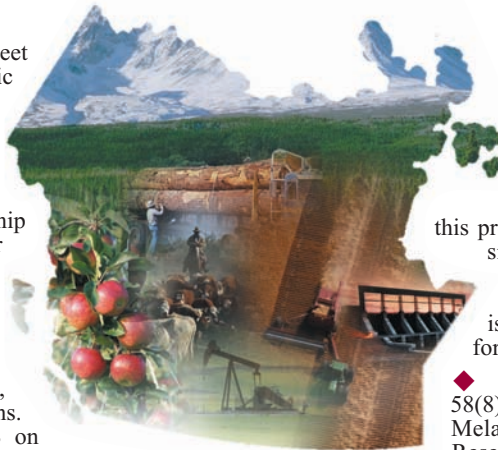

- ◆ Prince Rupert, located on the coast of Northwest British Columbia is expanding to meet growing needs as a port vital to the Asia-Pacific shipping corridor. In: *Prince of Ports* (BC Business; 35(7):60-66; July, 2007; www.bcbusinessmagazine.com), Don Whiteley discusses how Prince Rupert is planning to become one of the continent's key ports. A \$175 million government and private sector partnership to transform Prince Rupert into a vast container port is scheduled to begin this summer. As North America's closest port to Asia, Prince Rupert is situated on the shortest land/sea route to the US Midwest. It is linked by rail to Canada's West and East coasts and the Southern Gulf coast, and through affiliates to Mexico, offering seamless access to three NAFTA nations. Recently CN announced plans to spend \$1B on infrastructure including new equipment and new facilities, in Western Canada, partly in response to prepare for increased opportunities arising from development of Prince Rupert which is today Canada's second largest West Coast port. (www.rupertport.com)
- ◆ Mining is a long and well-established profession and one that is currently enjoying a growth spurt. In: *Mineral Explosion*; (BC Business Magazine; July 2, 2007; www.bcbusinessmagazine.com) Peter Mitham discusses how British Columbia's mining industry is growing and leading the country, contributing \$4.2B over the past year. In addition to world demand this growth is also the result of changes to provincial regulations that have made BC more welcoming than it once was to mining companies. In another article: *Rare Earth Elements* (Saskatchewan Business Magazine; 28(3): 27-33; May/June, 2007; goliath.ecnext.com) Keith Moen discusses an emerging business opportunity being exploited by Great Western Minerals Group, a Saskatoon based junior mining and exploration company. The new opportunities lie in the hybrid vehicle market where rare earth elements play a prominent role in batteries, regenerative braking system and the electric magnet motor. These rare earth elements are also used in a wide variety of other consumer goods. The pattern of increased demand is anticipated to continue for many years.
- ◆ Recently, the case has been raised for the use of nuclear energy as a source of power for the Alberta oilsands projects. This has not been without controversy. In: *Gone Fission* (Alberta Venture; 76-83; June, 2007;) Carol Harrington discusses the initial strong resistance which has now thought to have softened. A second article, *The Nuclear Option*, in Canadian Business: (80(16/17):33-35; August 13, 2007; www.canadianbusiness.com) also discusses the issue. Proponents and opponents argue over the environmental, technological, economic and safety aspects of nuclear power. Driving the use of nuclear energy is the need to reduce the amount of energy consumption and pollution resulting from the current energy needs for the oilsands development.
- ◆ Cold-fX® (www.cold-fx.com) is a leading over-the-counter nutraceutical widely used to defend the body against colds and flu's. Over ten years of research and clinical trials, some of which has been published in international peer-reviewed scientific and medical journals have demonstrated that COLD-fX is safe and effective and support the intended use for strengthening the immune system and for the prevention and relief of colds and flu. The story behind the success of CV Technologies Inc. the Edmonton based company is provided in *Trust and Ambition*; (Alberta Venture; 11(1):57-60; January, 2007; www.albertaventure.com). Highly successful in Canada the company is now looking at expanding globally. Currently the product has been approved by the US Food and Drug administration for sale only as a dietary ingredient.

◆ A Canadian-designed solution to power outages triggered by small animals is attracting the interest from one of the largest high-tech companies in the world — 3M. As described by Laura Severs in *Business Edge* (7(15): July 27, 2007; www.businessedge.ca) this Canadian-built solution created by a power lineman is designed to eliminate the 20% of power outages that are attributed to wildlife coming into contact with electricity transmission systems. 3M has obtained exclusive rights to sell and market the product called "Greenjacket" within Canada. The unique advantage of this product is that it can be customized to fit the size of the customer's power devices. It's not a one-size-fits-all formula. The company is now looking at marketing globally where it is believed that there will be a huge demand for this product.

- ◆ In: *Towards a Green China* (Oilweek; 58(8): 36-39; August, 2007; www.oilweek.com) Melanie Collison describes how the Alberta Research Council is preparing to export technology to China that will bring clean energy to its agricultural sector. The tremendous growth of the Chinese economy and the current massive pollution that exists clearly defines the countries need for environmental help.
- ◆ Research, Development and Innovation are critical if Canada's economy is to remain globally competitive. In: *60 Years of Smart Science Solutions* (Saskatchewan Business Magazine 28(4):11-18; July/August, 2007) Keith Moen discusses the contributions of the Saskatchewan Research Council in research, development and the transfer of innovative scientific and technological solutions, applications, and services. *Canada's Next Big Thing?* is the title of an article in Canadian Business (80(12):41-44; June, 2007; www.canadian-business.ca) that describes the semifinalists of the Great Canadian invention competition. The first of these in a trailer hitch aligner, the second a mascara remover, and the third a drywall fastener. In a speech to the Vancouver Board of Trade reported in *Business Edge* (7(11); June 1, 2007 www.businessedge.ca/article.cfm/newsID/15527.cfm) the President of the University of Alberta urges that British Columbia and Alberta should work together to research and develop new technologies. Finally, in an article by Guy Stanley in Policy Options (*Upgrading Canada's National Innovation System: More than Money Required*; 28(7):68-74; July/August 2007; www.irpp.org/po/) the author shares his opinion on why Canada's productivity growth is not keeping up with other countries. Stanley believes that we have the elements required to be successful but they are working at cross purposes and hence not effectively. The author provides two important suggestions for improving efficiencies that will support prosperity.

Author's Note: Information compiled from a variety of sources including; regional, provincial, and municipal business publications; and web-sites.

About the Author

Terrance Malkinson is a proposal manager/documentation specialist, an elected Senator of the University of Calgary, a Governor of the Engineering Management Society, international correspondent for IEEE-USA Today's Engineer Online, editor-in-chief of IEEE-USA Today's Engineer Digest, and editor of IEEE Engineering Management. The author is grateful to the Haskayne School of Business Library at the University of Calgary. He can be reached at malkinst@telus.net.



Trends and Challenges in Handheld Wireless Application Development

1.0 Introduction

The wireless industry is growing enormously with emerging standards in technology and newer communication protocols for accessing the networks. The manufacturers and network operators are introducing newer and more powerful handheld devices on the market, and are offering new and improved services. This has increased the popularity of handheld devices amongst masses, and hence has created need for new applications.

For application developers there is a great opportunity. They have wide choices with respect to hardware and development platforms, and face many challenges with respect to memory, processing power and input/output capabilities of handheld devices. The context of use of handhelds has pushed the need for minimal input and output, simple and intuitive user interactions and robust applications. Reduced memory footprint and addressing the computation/communication trade-off have become a necessity considering the limited memory and processing resources on handhelds. The nature of the wireless network also poses a challenge in terms of bandwidth and security.

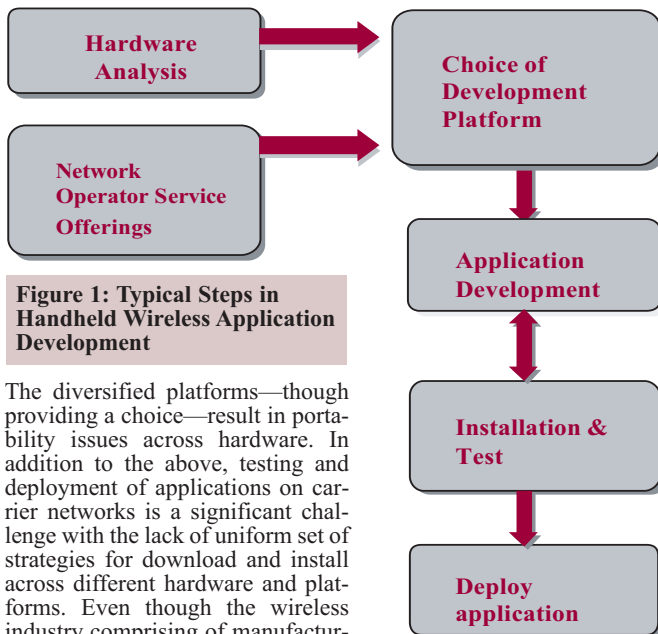

Figure 1: Typical Steps in Handheld Wireless Application Development

The diversified platforms—though providing a choice—result in portability issues across hardware. In addition to the above, testing and deployment of applications on carrier networks is a significant challenge with the lack of uniform set of strategies for download and install across different hardware and platforms. Even though the wireless industry comprising of manufacturers, network operators and platform vendors is working towards standards for billing, provisioning and deployment, there is no one simple solution that fits all scenarios. Hence based on the application and the consumer market, appropriate design choices have to be made during development, where the challenges and possibilities are endless.

2.0 Design and Development

The wireless handheld devices that are referred to here correspond to smaller devices such as programmable pagers, cell phones and some low-end PDAs personal digital assistants (PDAs). These devices are categorized based on their memory, operating systems (OS) and supported API or applications. Their key characteristics are outlined in Table 1.

From smaller development teams to smaller devices, developing for handhelds is significantly different than developing applications for desktops. Hence software engineering issues that affect the handheld development are unique. In the figure, an outline of the steps involved in development is presented. With the multitude of handheld devices, preliminary hardware analysis is critical to determine the minimal requirements for the application in terms of screen size, memory, and features of the handheld. For example a gaming application might require that the cell phone support wireless messaging API's for development and have a screen size of at least 96x54. Identifying these requirements early in

By *Lourdhu Rexi C. Joseph and Alagan Anpalagan*
Ryerson University, Canada

Abstract

Programmable handhelds such as cell phones and PDAs have brought an entirely new era in software development. Driven by the market, there is an increasing focus on creating new applications for these miniature wireless devices, where the challenges and possibilities are seemingly endless. While the wireless industry comprising of manufacturers, network operators and platform vendors is working towards achieving standards in billing, provisioning and deployment of applications for the handhelds, developers are faced with wide choices with respect to hardware and development platform, and many limitations with respect to memory, processing power and input/output capabilities of handheld devices. User interface design plays a significant role in providing for clear and concise content, intuitive navigation and simple output. This article addresses some of the key issues to be considered by developers in the design, development, deployment and testing of applications for wireless handheld devices.

Sommaire

Les appareils de poche programmables tels les cellulaires et ANPs ont introduit une nouvelle ère en développement logiciel. À l'instigation du marché, un accent croissant est mis sur la création de nouvelles applications pour ces appareils, et les défis et possibilités semblent illimités. Alors que l'industrie du sans fil composée de manufacturiers, opérateurs de réseaux et vendeurs de plateformes oeuvre à établir des standards de facturation, fourniture et déploiement d'applications pour les appareils de poche, les développeurs font face à un large choix de plateformes matérielles et logicielles, ainsi qu'à plusieurs limites concernant la mémoire, puissance de traitement, et capacité d'entrée/sortie de ces appareils. La conception d'interfaces utilisateurs joue un rôle significatif en fournissant du contenu clair, une navigation intuitive et un format simple. Cet article touche certaines problématiques clés considérées par les développeurs dans la conception, le développement, le déploiement et le test des applications pour appareils de poches.

Context of Use	Communication, Entertainment, Information look-up
Form Factor	Fits in a hand (less than 10 X 12 inches)
Display Screen	At least 96X54 pixels
Input	Numerical keypad, soft keys, stylus or wheel
CPU power	Order of 10 MHZ
Memory	Less than 2 MB of user memory
Connection	Wireless connection (through GSM, GPRS, CDMA)
Devices	Cell phones, pagers, low-end PDAs

Table 1: Key characteristics of handheld devices.

the development lifecycle will help to define the target audience for the application and determine the minimal hardware requirements for development and deployment. The next step is to study the network operators impact on the application being developed. Network operators may enforce strict security standards or favor certain development platforms to others. Hence it is important to consider these implications before proceeding with the implementation.

The OS together with the supported API's and development tools forms the development platform. The preliminary hardware analysis and a thorough understanding of the network operator services will be the best guide in choosing a development platform. Next major steps in the life-cycle involve development and testing on actual hardware. The development phase includes multiple iterations in user interface(UI) design, application design to reduce application size, memory and user input. Testing application for handhelds is a two-step process involving testing on desktop emulators and testing on actual target device. The emulators provide for preliminary testing on the desktops without the need for actual handheld hardware. Yet installation and testing on the device is an important step in determining the usability of the application, for often the emulators cannot accurately simulate the variety of devices available in the market and can provide only a generic implementation.

The last major milestone is the deployment of the application, where the application is made available for commercial use through OTA (Over-the-Air) provisioning. During deployment an important factor to consider is the application size. Bigger the application greater are the costs for the user for download and install. Security is another important factor. Depending on application functionality and the network operator, it may be required to certify the application before deployment. After deployment, a major part of the maintenance effort will be in handling portability issues when the application has to run on a different target platform, than the one for which it was originally developed.

3.0 Device and Platform Diversity

The number of different handset manufacturers seems to be growing continuously and there are multiple mobile devices every year, each loaded with one of the several different development platforms. In general handheld devices are classified into three categories: Mobile phones which are voice-centric, PDA's which are data-centric and the recently popular smart phones which combine the features of both PDA's and mobile phones. PDA's like HP's iPAQ or RIM's blackberry are best utilized for handheld computing tasks like accessing a corporate internet, chat and email. Whereas programmable mobile phones or smart phones have become affordable and provide for quick and easy access to information.

The development platform consists of the handset software and the development tools. The handset software mainly consists of the OS and APIs loaded by manufacturers. The development tools consist of editors, emulators, debuggers, and profilers that support the application development. Table 2 captures the major development platforms in use currently.

Operating System(OS)	Languages	Development Environment	Considerations
Symbian OS	C/C++, JAVA	Code Warrior	Network portability, Hardware portability, Availability of development tools, Ease of deployment
Windows Mobile	C++, Microsoft embedded VC++	Microsoft Visual Studio	
Palm OS	C/C++, JAVA	Code Warrior	
BREW	C/C++/JAVA,	BREW SDK	
J2ME	JAVA	WTK	

Table 2: Popular development platforms for handhelds.

A sample of operating systems includes Windows Mobile, Palm OS and Symbian. And the programming language could be C, C++ or JAVA. Due to varied hardware availability, tools such as emulators play a major role in development. Developers commonly test with an emulator before actual testing on a target device. Some of the platforms provide for sophisticated on-device debugging, wherein an application can be debugged on the handheld itself. This is a valuable feature considering that the development environment (desktop computer) and the target environment (Handheld) are uniquely different. Some platforms also provide tools for memory optimization and performance tuning.

Portability and security are the two main factors guiding the choice of the development platform. Development platforms such as BREW and J2ME are referred to as operation execution environments. The significant difference here is that the applications written on these platforms are executable on any OS. Applications written in C/C++ are native to a specific OS and may not be portable to another OS without interference from developers. Even with portable applications, the user interaction

and the UI look and feel may not be the same across hardware. This is because platform vendors like J2ME's Sun have little control over how the hardware is designed to render the UI.

Security is an important consideration for everyone, users, network operators, manufacturers and developers. The development platforms need to provide two kinds of security: Application security in terms of secure communication and safe processing during application execution. End-to-end security for safe download and install of application wirelessly onto the handheld device. Operating environments such as J2ME have an interesting security architecture, including code execution within the confines of the JVM and user-level permissions for certain sensitive actions such as network access. And for secure communication during application execution, communication over secure sockets layer is recommended.

4.0 Memory Constraints

One of the key constraints of the handheld devices is the memory. The handheld devices have far less physical memory than desktop personal computers and do not contain hard disk drives for storing large amounts of data nor exhaustive virtual memory. But there is a greater demand for memory resource with the sophisticated functionality provided by the handheld devices. Hence different OS vendors follow different strategies for optimizing the use of handheld's memory resources. For example Symbian OS, does not set hard limits on the volatile memory store (RAM) required for OS tasks, whereas Windows mobile and Palm OS manage the memory differently in that the RAM dynamic area for the OS tasks is reserved and cannot be shared for any user or program data storage as shown in the figure.

Increasing the size of the ROM or RAM on the basic handsets would mean an increase in product size or cost, hence some manufacturers provide for a memory upgrade to provide for additional storage through expansion slots for user data and system data as shown in the figure. Limited memory on handhelds often limit the size of the applications that can be executed (< 64kb in the mid-range programmable cell phones), and also the amount of runtime memory available for application execution. Applications that require large amounts of memory use the network resources for persistent storage, thus proving Sun's adage of "Network is the computer". Applications that require minimal persistent storage store directly to the handheld device. To optimize the use of available memory resources developers could follow certain simple strategies. They are:

- ▶ Use only the necessary features (bare minimum) of the underlying API's
- ▶ Store only information that needs to be persistent
- ▶ Use network resources wherever possible (i.e. cost conscious)
- ▶ Use fixed sized data structures, to avoid memory fragmentation and leaks

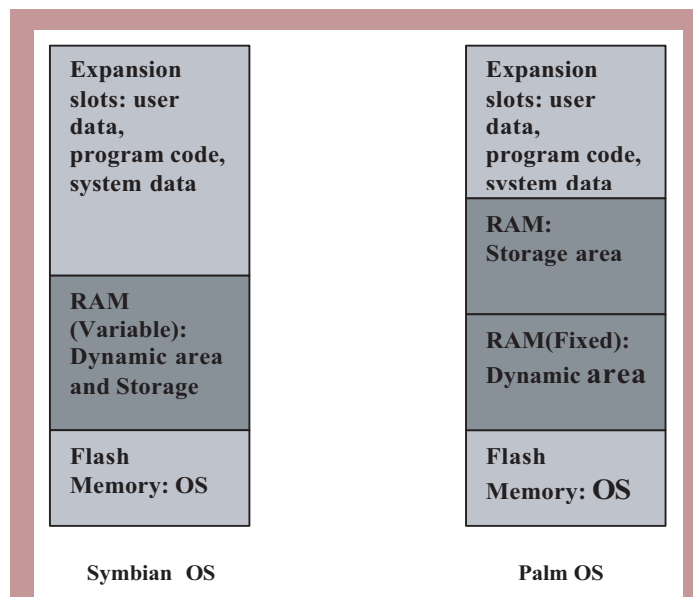

Figure 2: Memory resource optimization in handheld devices

Cost of the handhelds and battery power are the two main factors that directly impact the users. Processing power if increased might increase the battery power consumption, handset size or cost. Hence the available processing power is limited which limits the kind of applications one can develop for handheld devices. But recent advances in chip design have lead to moderate increase in CPU power up to the order of 312 MHz in smart phones.

One possible approach to executing applications that are hungry of CPU cycles is to off-load some computation to a remote server on the wireless network. This might increase the communication traffic, and hence the cost to the user. Thus there is a trade-off between communication and computation cost. Wireless applications that are common amongst smartphone users, such as standalone PIM (Personal Information Management) applications or applications with entertainment value such as games, require only limited processing. Some corporate networks provide wireless clients on PDAs for accessing email, and all the resources available within the intranet. These handheld client applications may generate more communication traffic where the costs are usually borne by the corporate networks.

Since many commercial applications require the handheld to be in powered-on mode for a reasonable length of time, battery power becomes a critical resource. Thus in order to run power-hungry applications, technology has to steadily improve, to pack the resources available on a large desktop into the much smaller handhelds. Some alternative strategies for augmenting the power resources on a handheld have been studied. These include recharging batteries wirelessly using solar power, and others suggest techniques such as cyber foraging and fidelity adaptation. With cyber foraging, handhelds can use nearby servers for processor resources. Whereas in fidelity adaptation, applications can alter their runtime parameters to minimize use of power resources thereby users choose to trade-off quality of application to battery power. But the ideal strategy would be to keep the handhelds small and augment their power resources externally as when application demands arise.

5.0 User Interface

The design and development of an intuitive user interface (UI) is the most challenging aspect of mobile application development. Smaller display area, minimal input keying and the context of use, all pose a major challenge when designing UI for a wireless handheld device. In traditional desktop applications, UI consists of multiple menus, and sub-menus all of which can be accessed by an exhaustive combination of keys. A user workflow in a desktop environment generally consists of navigating through a set of menu options, toolbar options or dialog boxes to initiate different functionality. But in the case of a cell phone, the keys available are limited and the alphabetic keys are overloaded. Hence UI with complex navigation or deeper menus is not suitable for handheld devices where most of the user actions are performed with a single hand. Also the smaller screen real estate on handheld devices necessitates presenting only the most crucial content. And since scrolling on handhelds is not easy and not as common as in PCs, the UI needs to be designed to accommodate the most relevant information in the very first page or even within a single screenshot with no scrolling.

The portability of the UI over different target hardware is also a major concern. "Write Once Run Anywhere" is possible with the support provided by certain development platforms like J2ME. But there are still small nuances, which require developers to modify their application to suit a new hardware platform running the same version of the operating environment. Most often the developer begins with a device independent UI design. But after testing on actual hardware, the developer is forced to tailor the UI based on a weakest link criteria: i.e. to fit the smallest screen size, the minimalist input capabilities and the grayscale screen in order to appeal to a wider audience. Thus the portable abstract UI design provided by certain development platforms although requires less development and maintenance effort, will result in variations in user interaction and look and feel. If the application is not sensitive to such UI differences, abstract UI design will be a good choice. In other cases, such as in gaming applications where the requirement for uniform UI interaction is significant, portable UI design may not be the choice, whereas writing native applications might yield better results.

6.0 Network Bandwidth

Thus wireless network poses a unique set of challenges not found in the wired medium of communication. Bandwidth is scarce and data communication is often expensive, slow (~9.6 kbps) and intermittent. Hence minimizing network access becomes an important factor while developing applications for wireless handhelds. But often handhelds augment their limited memory and battery power with the usage of network resources. Hence there is a trade-off between communication cost and use of handheld resources such as battery power and memory. There are certain simple design strategies that can be applied to mitigate this trade-off.

One of the ways to reduce communication costs is through SMS (Short Message Service), which is a low-cost alternative to Internet access from the wireless handhelds. Users are often charged per-kB rate for data transfer over a wireless network, whereas network operators provide text messaging at a very affordable price. SMS operates by out-of-band packet delivery through a store-and forward network. This requires very little bandwidth and still can provide for guaranteed delivery of data. It's suitable for applications that need to communicate with one another or the

Internet in short bursts. For example gaming applications, location-based services and even subscriber provisioning (device management) can use low-cost SMS. It can be received or sent even while a voice or data call is in progress, and can be unicast or broadcast to a set of subscribers.

Browser caching is another such technique that provides for optimized use of processor, memory and network resources. Data previously retrieved from a server on the network is stored onto the handheld device for future use to avoid repeated fetching. This is often referred to as caching. And also an efficient strategy based on LRU (Least Recently Used) is employed to remove any unused data from the cache.

Another strategy often researched in the industry is to make the network protocols such as link, MAC, routing and transport protocols, power-aware. This would provide for energy efficient means for transportation of applications or data in a wireless network, thus resulting in significant savings in battery energy for the handheld devices.

Thus developers need to apply newer design methodologies to accommodate for minimal use of communication and handheld resources while developing applications for handhelds.

7.0 Testing and Deployment

Once an application is successfully developed the next stage is testing and deployment of the application for use on the handhelds. Packaging and security are the main considerations before for testing and deployment of the application. Most of the development platforms provide tools for packaging the application i.e. to bundle all the resources such as images, permissions and application properties together. In order to provide for end-to-end security during application installation, some platforms provide for obfuscation or code mangling, discernible only by the software platform on the handheld, while others enforce security through application signing and public key encryption.

The two major ways of installing applications on handhelds are: download from a personal computer(PC) and over-the-air provisioning (OTA). In OTA download, the application is made available on the carrier's portal for commercial use. Users of web-enabled handhelds can download and install the application on their devices. The application can also be installed by downloading from a desktop via an USB, Bluetooth or infrared connection. This strategy is mainly used by developers for purposes of testing the application on the handhelds. But some manufacturers/network operators do not provide for direct download and installation of applications onto handhelds except through OTA for security reasons. In such cases, for testing as well as deployment OTA is the best available option.

The software that handles the installation of applications onto the handheld is often termed as the application management software. This software performs the tasks of identification, verification and installation of application on the handhelds, which are based on established OTA pro-



User interface is the key design challenge for mobile phones. Mapping of keys and menus is different across handsets and software for establishing PC connectivity is manufacturer-specific and not readily available.

visioning guidelines. In the case of download from a PC, software drivers for identifying and communicating with the handheld are required, which may not be readily available.

8.0 Local Connectivity to PC

In downloading the application for installation from a PC, the tester/developer has to be aware of the application packaging. The download can be via wired USB, or wireless Bluetooth or infrared communication. Initially this type of communication was used for synchronization of handheld content such as contacts, address book etc., with the content in the desktops. But now it has expanded to cover download of everything from images and music to applications. The most common synchronization protocol is the Palm's HotSync. Performance of these synchronization protocols in terms of usage of bandwidth, processing and memory resources is critical to the handheld devices.

For a developer the download from the network operator's portal, and then chooses to install the retrieved application onto the device. The main players in OTA are:

- The network operator providing for such a OTA download
- Developers providing content on the web
- Handheld devices with the capability to discover, download and install the application

OTA download and install is possible only if the network operator provides for such a service. In its simplest the handheld device should have an option to "Download Applications", and the network operator should have a content server providing wireless applications for download. When the user chooses "Download Applications", the user is redirected to an application server maintained by the network operator. Now the user can choose an application for download. Applications for handheld devices are usually packaged in two parts: the application descriptor and the application archive. As a first step the application descriptor is first downloaded onto the handset, its source verified and presented to the user for acknowledgement. On receiving confirmation from the user, the actual application is downloaded and installed onto the device. While some network operators might have an exhaustive provisioning portal providing access to PIM applications, downloadable ring tones etc., others may not allow for installation of untrusted applications onto handheld devices, for security reasons.

A trusted or signed application is verified to adhere to a set of criteria enforced based on the requirements from network operators and handset manufacturers. This ensures that the device is not unduly tampered by installation of untrusted software. There are many companies that provide for this verification and signing of applications authorizing trusted content. Thus during packaging the developer has to consider application signing before deployment through OTA on carrier's networks.

9.0 Summary

In developing for programmable mobile phones, when compared to all others, user interface design poses a significant challenge. Irrespective of portability issues, user interface rendering and user interaction (mapping of keys & menus) is different across handsets. Also software for establishing PC connectivity is manufacturer specific and is not readily available, and hence can add to the testing effort significantly. The following list summarizes the key issues to be considered by developers while designing, developing and deploying applications for handheld devices:

1. Understand users, manufacturers and network operators role
2. Determine the capabilities of target hardware

3. Focus on simple and intuitive, user interface design
4. Reduce program size and data
5. Design for minimal input/output
6. Limit processing on the device and optimize network usage

10.0 References

[1] Lettieri, P.; Srivastava, M.B. "Advances in wireless terminals," IEEE Personal Communications, vol. 6, no. 1, Feb. 1999, pp 6 - 19.

[2] Y. B. Sukaviriya, N. Derby et.al, "Lessons learned in deploying a wireless, intranet application on mobile devices," Proceedings of Fourth IEEE Workshop on Mobile Computing Systems and Applications, June 2002, pp 31-39.

[3] C. Yang, K. Tien, M. Wueng, "Browser cache management for small wireless devices with memory and

bandwidth constraints," Proceedings of the Fourth International Conference on Parallel and Distributed Computing, Applications and Technologies, PDCAT'2003, Aug 2003, pp 356-360.

[4] S. Agarwal, D. Starobinski and A. Trachtenberg, "On the Scalability of Data Synchronization Protocols for PDAs and Mobile Devices," IEEE Network, vol. 16, no. 4, July 2002.

[5] Medvidovic. N, Mikic-Rakic. M, et.al, "Software architectural support for handheld computing," IEEE Computer, vol:36, no. 9, Sept. 2003, pp 66 - 73.

[6] Rajesh Krishna Balan, "Powerful change part 2: reducing the power demands of mobile devices," IEEE Pervasive Computing, vol.3, no. 2, April-June 2004, pp 71-73.

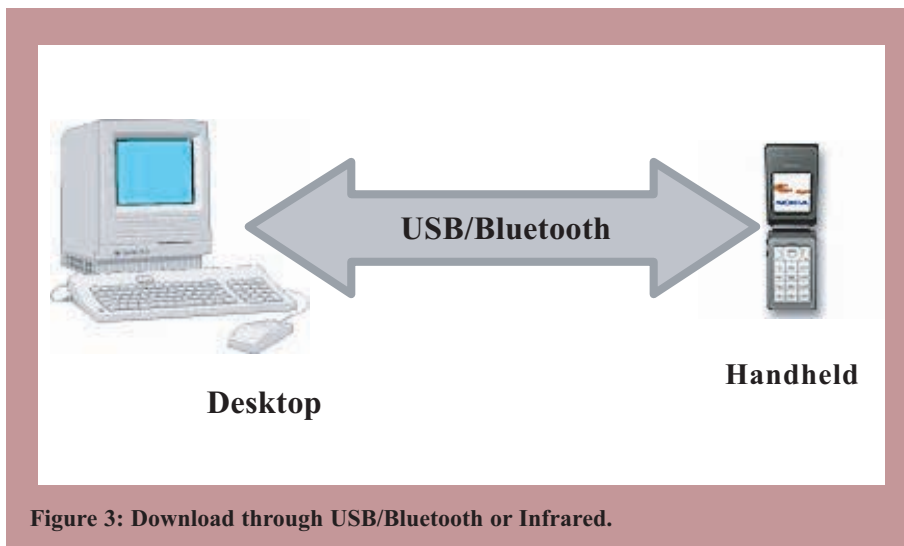

Figure 3: Download through USB/Bluetooth or Infrared.

About the Authors

Lourdhu Joseph received her MEng from Ryerson University in 2005 and her research interests are in application software development.



Alagan Anpalagan is an Associate Professor and Graduate Program Director at Ryerson University and his research interests are in wireless communications and networking.



Next Generation Wireless Systems and Networks

Authors: Hsiao-Hwa Chen and Mohsen Guizani

Publisher: John Wiley, 2006

ISBN: 0-470-02434-8

No. of pages: 512

This self-contained reference offers a view of cutting-edge Beyond-3rd-Generation (B3G) wireless applications. Combining the basics of wireless communications — such as 3G wireless standards, spread spectrum and CDMA systems — with a more advanced level research-oriented approach to B3G communications, it eliminates the need to refer to other material. The book will provide readers with the most up-to-date technological developments in wireless communication systems/networks and introduces the major 3G standards, such as W-CDMA, CDMA2000 and TD-SCDMA. It also includes a focus on cognitive radio technology and 3GPP E-UTRA technology. Main features include:

- Hot topics in the area of next generation wireless from the authors' own research, including: Bluetooth, all-IP wireless networking, power-efficient and bandwidth-efficient air-link technologies, and multi-user signal processing in B3G wireless.
- Step-by-step progression throughout the book will provide the reader with a thorough grounding in the basic topics before moving on to more advanced material.
- Addresses various important topics on wireless communication systems and networks that have emerged only very recently, such as 4G wireless, cognitive radio technology, OFDMA and MIMO.
- Wealth of explanatory tables and illustrations.

This reference will prove invaluable to senior undergraduate and postgraduate students, academics and researchers. It will also be of interest to telecommunications engineers wishing to further their knowledge in this field.

This book is an outgrowth of the idea that the next generation wireless communication has a close interplay between physical layer (system level) and upper layer (network level) design. In the last decade, the explosive growth of mobile and wireless communications has brought a fundamental change to the design of wireless systems and networks. The demands on traditional voice-centric services have been quickly overtaken by data-centric applications. The circuit-switched end-to-end connection communication system and network design philosophy has been replaced by all-IP packet-switched connectionless architecture. The traditional layered architecture of wireless communication systems or networks has faced a great challenge from cross-layer optimized design, and the boundaries between the seven OSI layers—which used to be clearly defined—are narrowing.

On the other hand, the advancement in micro-electronics has made it possible to implement a complex communication end-user terminal in a pocket-sized or even a namecard-sized handset. At the same time, the data transmission rate through a wireless air-link has been increased tremendously, from 9.6 kbps in 1995 (on GSM) to 2 Mbps in 2005 (on WCDMA system), increasing by more than 200 times in the past ten years. The worldwide research community has targeted “4G” or “Beyond-3G” wireless systems and networks with a peak data transmission rate can reach as high

Review by Dr. Habib Hamam, SMIEEE

Université de Moncton

as 1 Gbps, as demonstrated in the very recent field trials made in Japan by NTT DoCoMo. The great demands on the capacity and quality offered over wireless communication links have pushed all of us hard to innovate all new design methodologies and concepts for wireless systems and networks.

This book project was initiated to respond to the evolutionary trend in the design of wireless systems and networks. It is written as an effort to offer a handy reference, which has taken in almost all essential background knowledge of wireless communications on both system level and network level, including fundamentals of wireless communication channels, almost all major 2G to 3G mobile cellular standards, wireless LANs, wireless PANs, Bluetooth, All-IP wireless networking, B3G wireless, and other recently emerging technologies, such as UWB, OFDM, cognitive radio and MIMO systems. Inevitably, it was extremely difficult to write this book in the sense that the authors had to make a great effort to keep a good balance on the completeness of the coverage and limited page budget. The authors hoped that this project has achieved the goal and will be appreciated by the readers.

All together, there are eight chapters covered in this book. As mentioned earlier, the primary goal is to offer an up-to-date research reference, which provides the readers with almost all important technological advancements in wireless systems and networks achieved in the last 20 years. The book includes virtually all major third generation mobile cellular technologies, such as CDMA2000, WCDMA and TD-SCDMA technical standards. The coverage on those 3G mobile cellular technologies has been tuned to a level, at which their working principles, design philosophies and salient features can be easily understood without the need to refer to other references given at the end of this book. However, the focus of this book has been put on newly emerging technologies, such as Ultra-Wideband (UWB), Multi-Carrier Code Division Multiple Access (MC-CDMA), Orthogonal Frequency Division Multiplex (OFDM), Multiple-in-Multiple-out (MIMO), cognitive radio technology and Beyond-3G (B3G) systems.

This book can also serve as supplementary teaching material for communications-related courses taught for either undergraduate or postgraduate students majoring in Electrical and Computer Engineering, Computer Science, or Telecommunications Systems. If used as teaching material for undergraduate students, the best effects will be achieved if the students have already taken some prerequisites, such as “Signals and Systems” and “Digital Communications”, etc. Good background of engineering mathematics will also be desirable to easily follow the advanced part of the materials presented. In addition, it can also be successfully used as the main teaching material for professional training courses, which may cover as long as a full semester/term.

For future editions, I would like to suggest to the authors to make the connection with the following interesting new fields: sensor networks, wireless sensor Networks, intelligent wireless systems and intelligent sensor networks, security issues in wireless systems and sensor networks.

Habib Hamam is a Professor in the Department of Electrical Engineering at the Université de Moncton and a Canada Research Chair holder in “Optics in Information and Communication Technologies”. His research interests include optical telecommunications, diffraction, fiber components, optics of the eye, biomedical engineering and E-Learning.

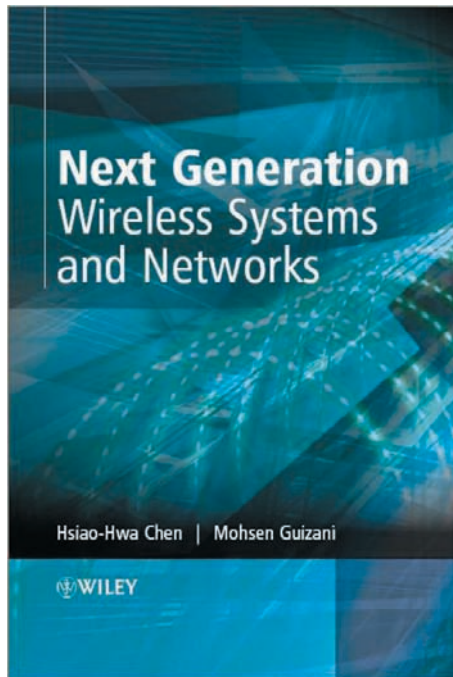

SIMULINK™-based Wireless System Design and Performance Analysis

1.0 Introduction

Many people worldwide communicate regularly using cell phones. In fact, many cell phone subscribers increasingly use their cell phones as home phones as well. Also, many people use wireless networking at home, school, work or all of the above. All of these technologies would not be possible if not for the experience of wireless communication system designers.

Much of the current research has been focusing on a single part of wireless communication system. Thus, to design a complete system would take the contributions of many. This article will attempt to serve to fill a void and will help to bring together the work of many different fields of research to build a complete wireless communication system in SIMULINK™. It is motivated by the idea that a chain is only as strong as its weakest link. It will systematically develop a SIMULINK™ block diagram of a wireless communication system that is based upon fundamental wireless communication theory and building blocks. The theory will be presented intuitively, rather than mathematically as the beauty of wireless system theory can only be truly appreciated at this level. Also, an experiment to explore the performance characteristics of such a system will be developed and the experimental observations will be presented. To conclude, the paper will suggest some minor modifications to the system that will substantially expand the scope of needs it can be tailored to.

2. Theory In A nutshell

To follow are descriptions of the most commonly researched components in wireless communications. Before continuing, the reader is urged to study Figure 1, which provides an overall view of a complete wireless communication system. It should also be noted that the source coding block, the equalizer block and diversity combiner blocks are left for future study.

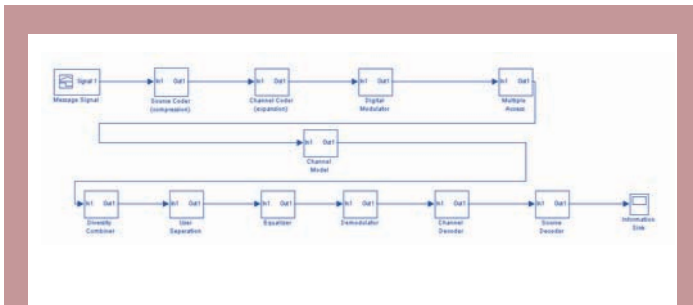

Fig. 1: Basic Wireless Communication System Block Diagram

2.1 Channel

The model of a wireless channel must take into account small-scale (fast) fading and large-scale (slow) fading. Small-scale fading occurs over small distances, or alternatively, in small time frames. This small-scale fading has three sources. The first source is rapid changes in signal amplitude usually characterized by a Rayleigh probability distribution. Equation (1) describes the Cumulative Density Function (CDF) of the Rayleigh distribution.

$$P(R) = 1 - e^{-\frac{R^2}{2\sigma^2}} \quad (1)$$

Physically, it represents the probability that a signal will take on a value less than or equal to R and requires knowledge of the variance. In a wireless communication system, good experimental approximations of this variance are known or can be measured. The second source is time dispersion due to time delay and it occurs when multiple versions of the message signal arrive at different times. This time dispersion makes it difficult to identify what signal was sent. Third, frequency modulation due to Doppler shift causes the frequency spectrum of the message signal to 'sway' back and forth around a central frequency. In other words,

By Alexander Hamlyn and Alagan Anpalagan
Ryerson University, Toronto, Canada

Abstract

Robust and high data rate wire-free communication capabilities are revolutionizing the world. In the technology development process, we often build software simulation models to verify the expected behavior in the lab, then build a hardware prototype with real world constraints before the final mass production. In this article, we systematically develop a SIMULINK™ block diagram of a wireless communication system that is based upon fundamental wireless communication theory and building blocks. Also, experiments to investigate the performance characteristics of such a system with different channel conditions, modulation schemes and coding techniques are presented and the experimental observations are discussed.

Sommaire

Les communications sans fils robustes et à haut débit révolutionnent le monde. Dans le processus de développement technologique, nous concevons souvent des modèles de simulation logiciels pour vérifier en laboratoire le comportement prévu, puis concevons un prototype matériel avec contraintes du monde réel avant d'aller en production de série. Dans cet article, nous développons systématiquement un schéma de principe SIMULINK™ d'un système de communication sans fil qui est basé sur la théorie fondamentale du domaine et des schémas de principes existants. De plus, des expériences pour examiner les caractéristiques de performance d'un tel système avec diverses conditions de canaux, schémas de modulation et techniques de codage sont présentées et les observations expérimentales sont discutées.

we can only guarantee an area that the spectrum can be in, but not the actual frequency. These Doppler shifts cause errors during signal reception.

Large-scale fading occurs during propagation of an electromagnetic field through space. Equation (2) relates the electromagnetic power received at the receiver's antenna to antennas' geometry and gain. For the exponent of d , a value of 2.5 is assumed for the experiment and the remainder of the quantities are assumed to be unity.

$$P_r = \left(G_t G_r \frac{h_t^2 h_r^2}{d^n} \right) \quad (2)$$

To combat fading effects, several methods have been proposed in the literature. The following sections will address modulation, multiple-accessing and channel coding methods to improve BER performance, power efficiency, bandwidth efficiency and total channel throughput.

2.2 Modulation

Fundamentally, modulation is designed to prepare a message for transmission. Many methods have been proposed, but three commonly used in wireless communications are Gaussian minimum shift keying (GMSK), binary phase shift keying (BPSK) and quadrature amplitude modulation (QAM). In GMSK, the frequency of the carrier varies between two different values based upon the digital input signal. To improve bandwidth efficiency, the input signal is spectrally rounded using a Gaussian pulse. A block diagram of a GMSK modulator, as well as timing diagrams for an arbitrary input signal, are presented in Figure 2. In BPSK, the phase shift of the carrier takes on two different values based upon the digital input signal. By convention, the two phase values are normally 180 degrees out-of-phase. In QAM, the magnitude of

the carrier is varied between two different values based upon the digital input signal. To improve the transmit bit rate, QAM transmits two bits simultaneously on two separate carriers, which are 90 degrees out-of-phase.

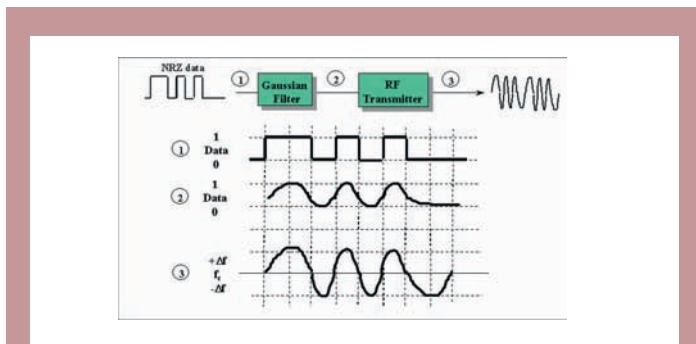

Figure 2: GMSK Block and Timing Diagrams (source: <http://sna.csie.ndhu.edu.tw/~cnyang/mobile/sld083.htm>)

2.3 Multiple-Access

Assembling and testing wireless communication equipment can be quite expensive. To make the system more cost effective, it must allow many customers simultaneous access. To do so, multiple-access schemes are employed which associate different users of the system with a physical quantity. Knowledge of this quantity can allow different user's information to be separated at the receiver. In code-division multiple-access (CDMA), each user is associated with a code. By multiplying by a sequence of codes at the transmitter, and again by that same code at the receiver, the signal from a single user can be separated. A CDMA block diagram is shown in Figure 3.

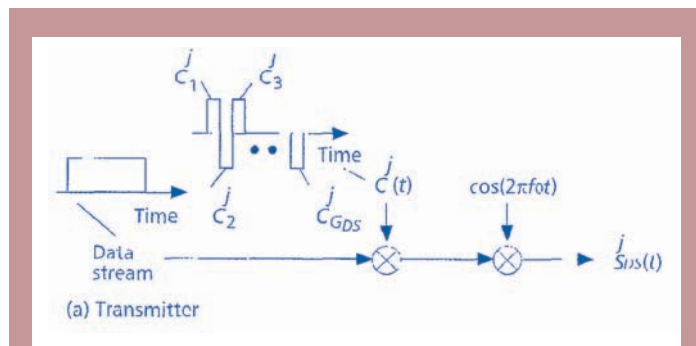

Figure 3: CDMA Block Diagram

In time division multiple-access (TDMA) each user is given a time slot. Outside of this time slot, a user's device may not transmit and any information to be transmitted must be stored until the next time slot becomes available. A drawback of TDMA is that the maximum user capacity is determined by the number of time slots available. In system design, creating too many time slots results in a time delay between a user speaking and the listener hearing. Conversely, creating too few time slots does not allow full use of the wireless system.

In frequency division multiple-access (FDMA) each user is given a frequency band to transmit in. FDMA has the advantage of being the most inexpensive to implement but has the same limitations on band allocation as TDMA.

2.4 Channel Coding

The goal of channel coding is to improve the BER performance of a wireless communication system by adding extra information to the message signal, before modulation. This serves to improve the probability of the correct message bit being received. Inherently, this approach will decrease the BER, but at the expense of increasing the data rate of transmission. The message data can be encoded using either a block encoder or a convolution encoder. A block coder receives bits continuously, but encodes and transmits in bursts. Alternatively, a convolution channel encoder continuously encodes and transmits. To decode a signal that has been encoded, a Viterbi decoder, which employs the Viterbi algorithm, can be used.

3. Experiment using Software Tools

Building a wireless communication system, using electronic hardware, can be quite time consuming. The development of the complete system may take years. To speed up the development process, software tools can be employed to simulate the system. MathWork's™ MATLAB™ and SIMULINK™ packages will be employed for this purpose. This section will describe the block structure of a robust wireless communication system in SIMULINK™.

3.1 Channel

To simulate the Rayleigh multi-path fading, slow fading and the AWGN generated in the channels, the block diagram in Figure 5 was constructed. The gain block serves to simulate the losses in electric field intensity as it propagates. The mask in Figure 4 is used to control the channel. The parameters of interest to a wireless systems designer are the SNR of the channel the delay vector, containing a column vector of integer representing the delay in symbol periods of each multi-path component, the Doppler frequency and the distance between the transmitter and receiver. Figure 6 shows the structure of the multi-path Rayleigh fading block. In this figure, the DSP constant block is used with the multiplier to create a number of copies of the original signal. Each of these copies is then delayed by different amounts using the Integer Delay block, and then each copy is multiplied by a Rayleigh Envelope Generator to simulate fading. The multi-path components are then added to simulate superposition of the electric field vectors in space.

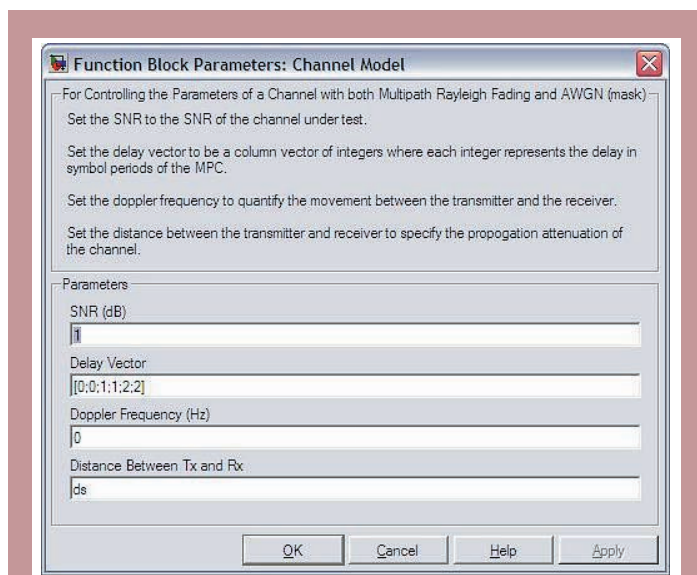

Figure 4: Mask of Channel Model in Fig. 5

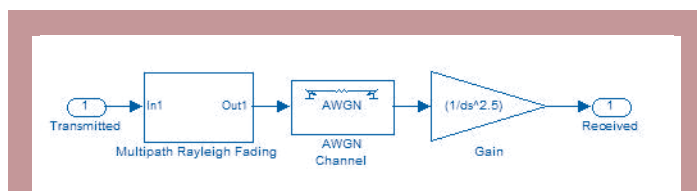

Figure 5: Channel Block Diagram

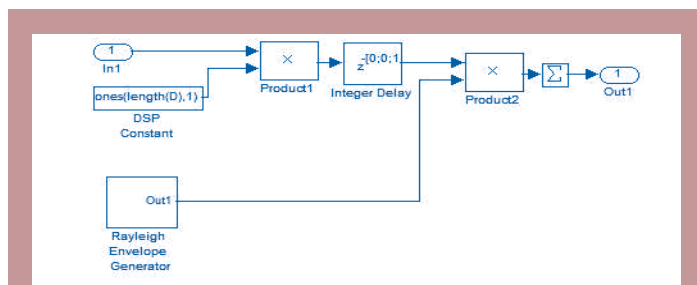

Figure 6: Multi-path Rayleigh Fading Block

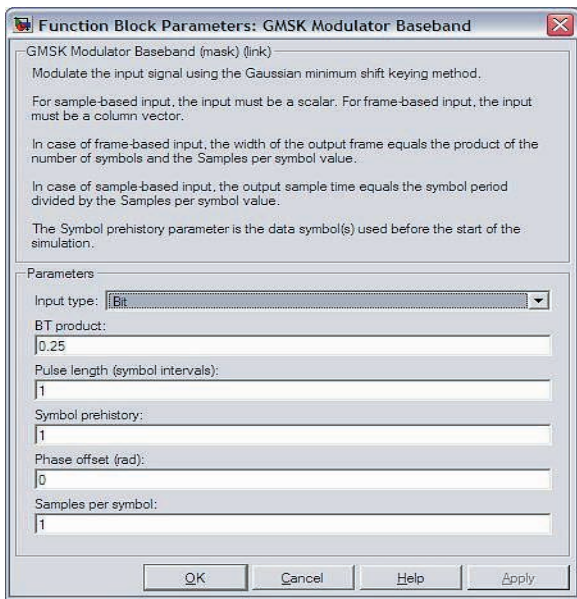

Figure 7: GMSK Block Mask

3.2 Modulation

Building a GMSK modulator from first principals was not necessary as SIMULINK™ already has the necessary block structure. A mask of the GMSK block is shown in Figure 7.

3.3 Multiple-Access

As CDMA is the dominant technology, it will be used in the SIMULINK diagram. SIMULINK™ has the blocks for generation of spreading codes, it was necessary to multiply the input signal by these spreading codes. The user separation block found at the receiver will follow the same procedure. The CDMA and user separation diagrams are in Figures 8 and 9, respectively.

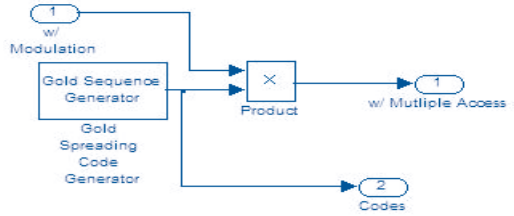

Figure 8: CDMA Block

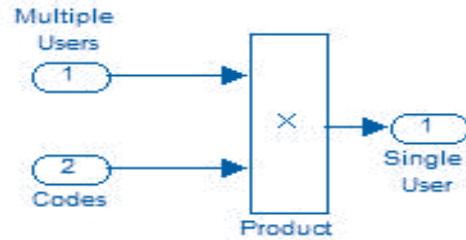

Figure 9: User Separation Block

3.4 Channel Coder

The SIMULINK™ convolution encoder bk will be employed along with the Viterbi decoder to simulate these subsystems in the wireless communication system.

4. Simulation Results

The number of multi-path components, as well as the Doppler shift in the channel, significantly alter the BER and are thus important to a wireless study. Simulations of the channel were conducted under the influence of 2, 4 and 6 multi-path components at various Doppler frequencies. Specifically, simulation results for a Doppler frequency of 40Hz is in Figure 10, simulation results for a Doppler frequency of 12Hz is in Figure 11, and simulation results for a static channel, with no Doppler shift, is in Figure 12 (see page 18 for Figures 11 & 12).

4.1 Effects with Modulation

With the addition of modulator, the BER should be expected to drop drastically as the signal is essentially changing faster, thus reducing the effects of slow fading. Results were obtained for a channel with Doppler shifts of 40Hz, 12Hz and 4Hz, and in the presence of a static channel. Simulation results were obtained for various BT products of the GMSK filter. Specifically, simulation results for BT=0.25 with $f_d=40\text{Hz}$ is shown in Figure 13 (page 18), for BT=0.25 with $f_d=12\text{Hz}$ is shown in Figure 14 (page 18) and BT=0.25 with $f_d=4\text{Hz}$ is shown in Figure 15 (page 19). Also simulation results for a static channel, with BT=0.25 is shown in Figure 16 (page 19), with BT=0.2 is shown in Figure 17 (page 19) and with BT=8 is shown in Figure 18 (page 19). The influence of BT on the BER vs. SNR relationship is demonstrated in Figure 19 (page 20).

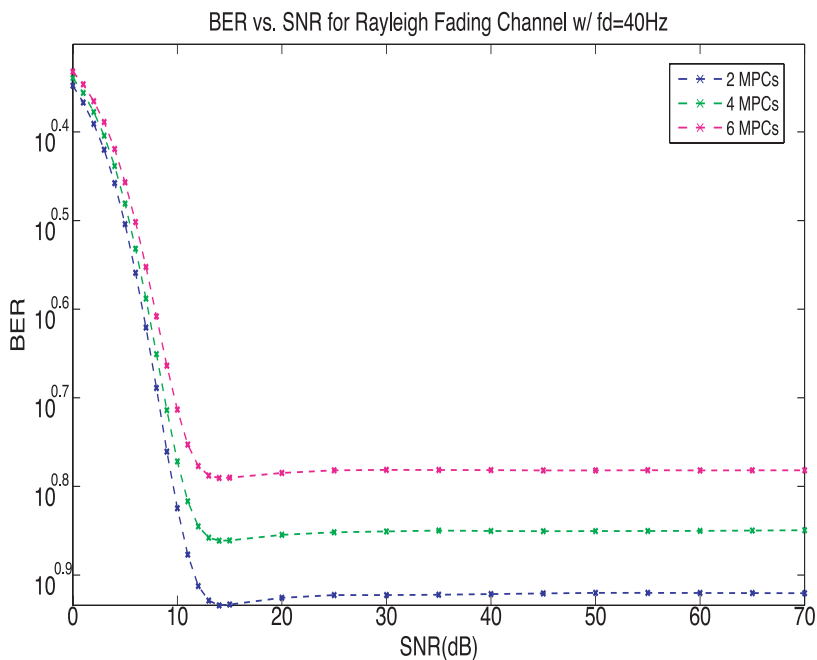

Figure 10: Performance under dynamic channel with $f_d=40\text{Hz}$

4.2 Effects with Multiple Access

With the addition of the CDMA scheme, the BER should be expected to decrease. The CDMA block was constructed in the presence of various modulators. Results were obtained for a channel with Doppler shifts of 40Hz and six multi-path components and are in Figure 20 (page 20).

4.3 Effects with Channel Coder

With the addition of channel coding, the BER should be expected to decrease dramatically. Results were obtained for a channel with Doppler shifts of 40Hz, six multi-path components under GMSK, BPSK and QAM, and CDMA with the addition of the channel Encoder and Viterbi decoder. Simulation results are shown in Figure 21 (page 20).

5. Conclusions

In conclusion, the experiment was successful to build a SIMULINK™

model of a wireless communication system. For a complete view of the effect of various system components, see Figure 22 (page 20).

5.1 Future Experiments

Future experiments should expand the scope of the system to cater to the needs of many different needs. The following list is certainly not exhaustive but should cater to the needs of many experimenters:

Add multiple user capability: To modify the system to handle many different users, all that would be necessary is to create a SIMULINK™ subsystem mask of the wireless communication system. The mask should be able to control the channel parameters, the modulation technique and parameters, the gold spreading code parameters used for the CDMA block and the trellis structure in the convolution encoder and Viterbi decoder. Each user would then utilize a different version of this subsystem. Each user would only need to use different gold spreading code parameters.

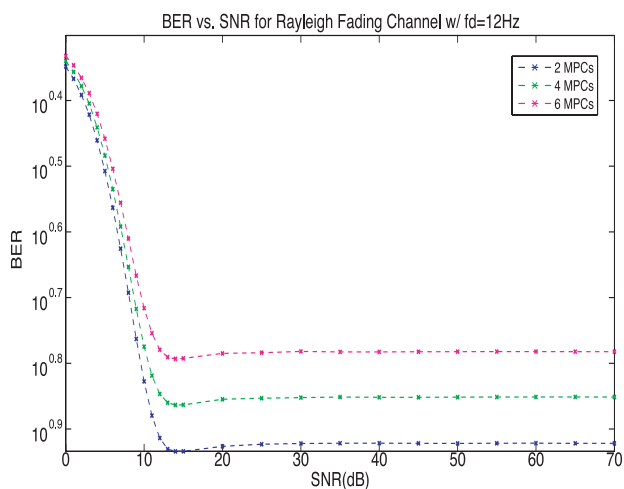

Figure 11: Performance under dynamic channel with $f_d=12\text{Hz}$

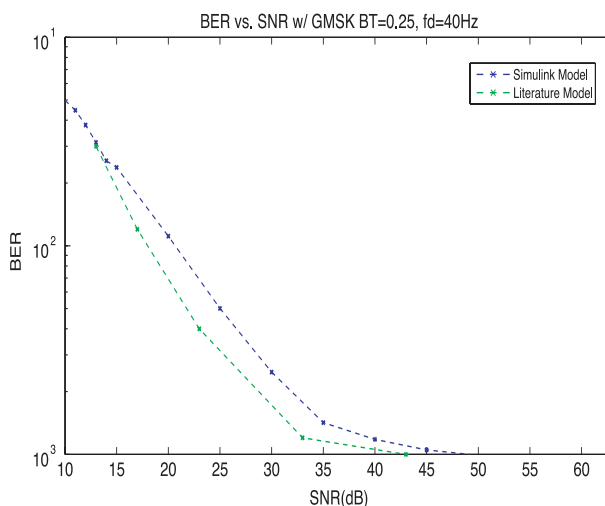

Figure 13: GMSK, $BT=0.25$, $f_d=40\text{Hz}$

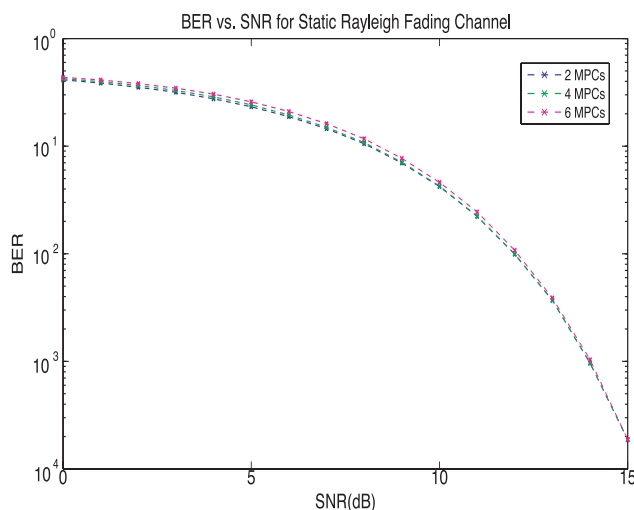

Figure 12: Performance under static channel

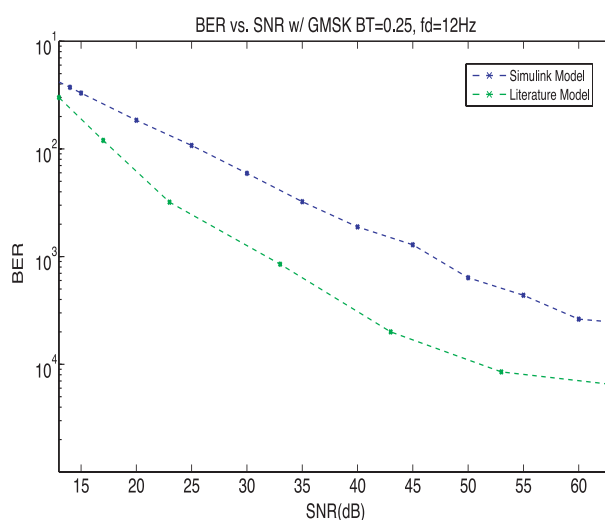

Figure 14: GMSK, $BT=0.25$, $f_d=12\text{Hz}$

Add a Rake receiver: In this experiment the worst-case system behaviour was observed when the number of multi-path components was at a maximum. With the inclusion of a Rake receiver, the BER would improve as the number of multi-path components increased. The reason for this, a Rake receiver can actually separate the multi-path components and effectively absorb power from them.

Two-way communication: In most wireless systems, the base station and mobile station are in constant two-way communication with each other. Thus, the performance of system which can transmit in both directions would be an interesting course of study. To implement this using the SIMULINK™ model, it would be necessary to duplicate the full communication system, but to reverse the direction of the 2nd system. Also, because the base station and mobile station utilize the same channel, provisions must be made in the channel model.

MATLAB GUI: To consolidate the system so a system designer may not be concerned with the functionality of SIMULINK™, but of the system

itself, a MATLAB Graphical User Interface (GUI) could be constructed. This system could control all of the simulation parameters from simple user commands.

6. References

- [1] T. Rappaport, "Wireless Communications: Principals and Practice." Prentice Hall. 2001.
- [2] K. Murota, and K. Hirade, "GMSK Modulation for Digital Mobile Radio Telephony." IEEE Transactions on Communications, July 1981, Vol 29, No7.
- [3] S. Hara, and R. Prasad "Overview of Multicarrier CDMA." IEEE Communications Magazine, Dec 1997. P. 126-133.

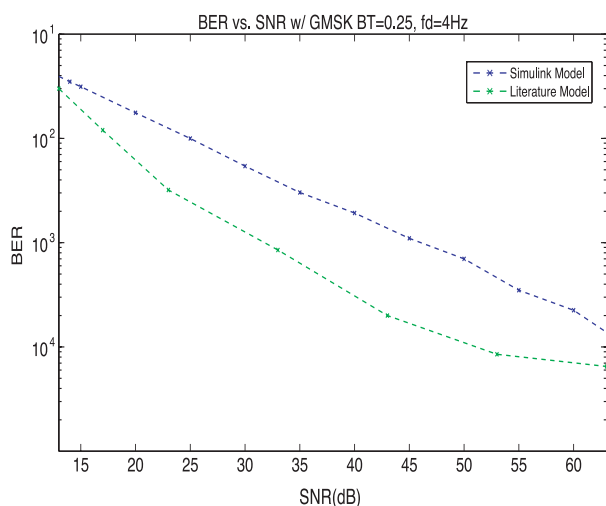

Figure 15: GMSK, BT=0.25, fd=4Hz

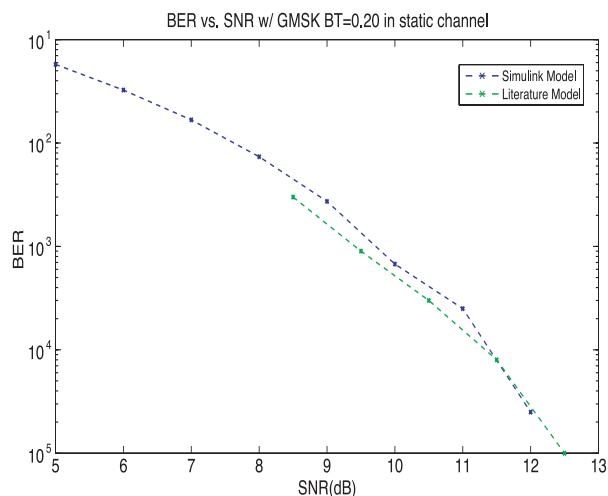

Figure 17: Performance with GMSK, BT=0.2, fd=0Hz

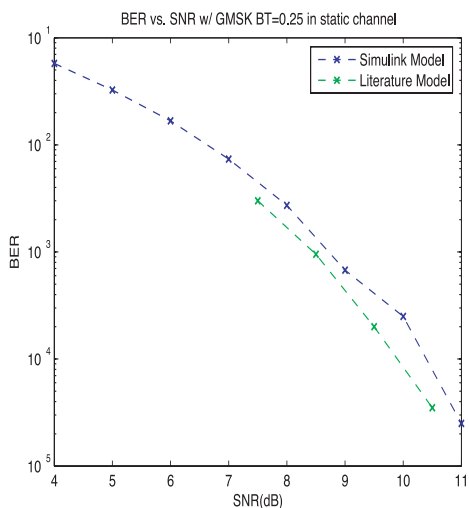

Figure 16: GMSK, BT=0.25, fd=0Hz

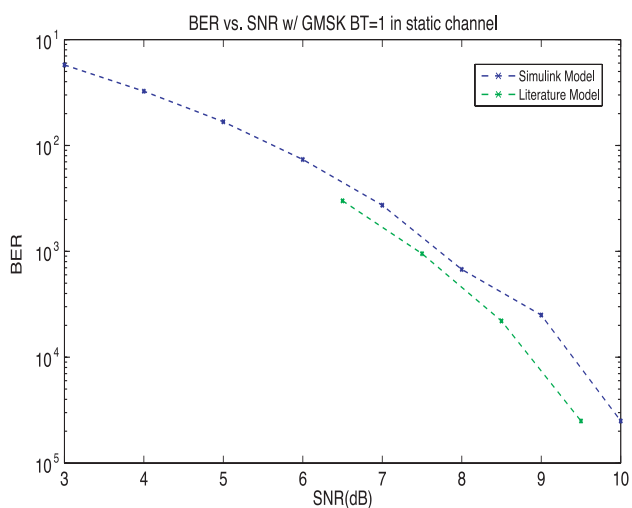

Figure 18: Performance with GMSK, BT=8, fd=0Hz

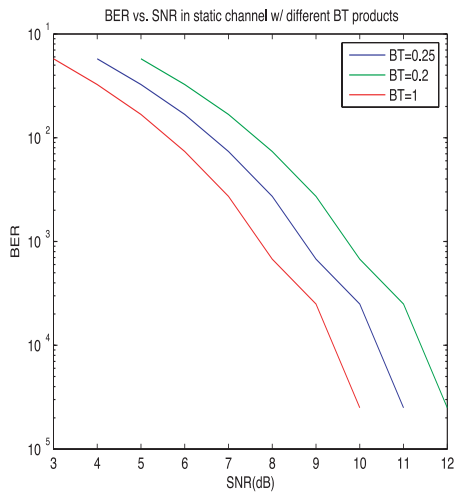

Figure 19: Effect of BT on BER

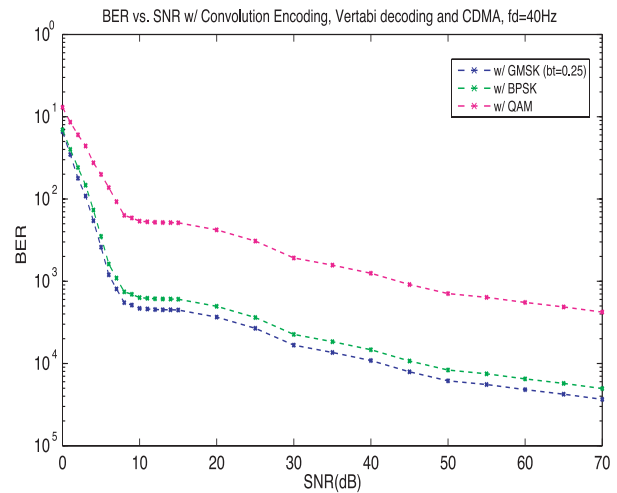

Figure 21: Effects of Channel Coding/Decoding and CDMA with various modulation schemes

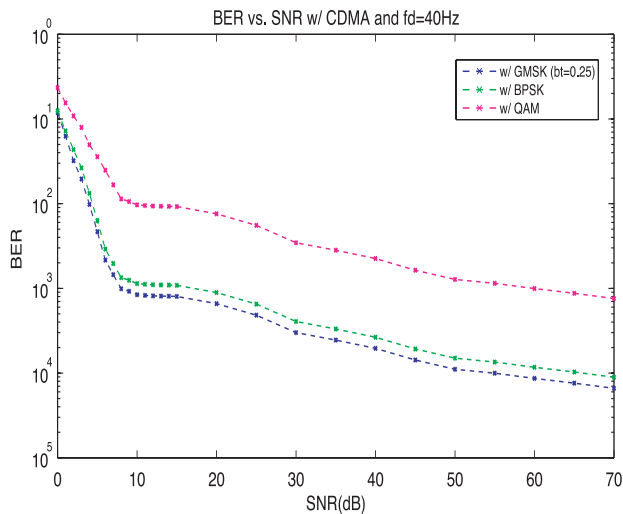

Figure 20: Effects of CDMA with various modulation schemes

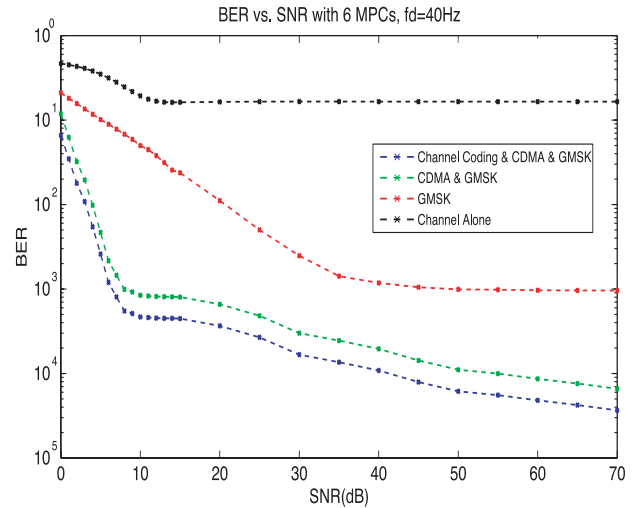

Figure 22: Effect of addition of system components on BER vs. SNR relationship

About the Authors

Alexander Hamlyn is currently a graduate Electrical Engineering student at Ryerson University pursuing his MASc degree. His research interests are in wireless systems performance modeling and analysis.

Much of the research and experimentation pertinent to this manuscript were completed in the Summer of 2006 while he was working as an NSERC USRA in the WINCORE lab.

Mr. Hamlyn was a recipient this past spring of an NSERC Postgraduate Scholarship and an Ontario Graduate Scholarship, Masters.



Alagan S. Anpalagan received his Ph.D. degree in Electrical Engineering from the University of Toronto in 2001. Since August 2001, he has been with Ryerson University where he co-founded WINCORE laboratory in 2002 and leads the WAN (Wireless Access and Networking) R&D group. Currently, he is an Associate Professor and Program Director for Graduate Studies. His research interests include: wireless communication, mobile networks and system performance analysis; and in particular, QoS-aware radio resource management, joint study of wireless physical/link layer characteristics, cross-layer resource optimization, and wireless sensor networking.



A Brief History of MPB Technologies Inc.

Challenges in Emerging Technology Commercialization — A Member's View

1.0 The early years

On January 3, 2007, MPB Technologies Inc. observed its 30th anniversary. It was on this date in 1977, that a group of eight scientists, engineers and technicians (soon to be joined by four more) spun off from the Research Laboratories of RCA Canada and embarked on their own adventure. The initial business of the new Company was principally R&D contracts with an alertness for opportunistic product possibilities. Some of the more noteworthy early accomplishments included an Airborne Imaging Radiometer (AIMR) flown by the Canadian Department of Natural Resources, the Aquatic Research Facility (ARF) flown on the Space Shuttle during Marc Garneau's initial space flight where he was the mission specialist operating the experiment, the Microgravity Isolation Mount (MIMS) for the Canadian Space Agency which flew for a number of years on the MIR Russian space station and eventually went down when MIR was decommissioned, the telemetry calibration transponders for Radarsat 1, and for about 10 years, a major participation (~ 20 people) in the Canadian Magnetic Fusion Program resulting in the design, construction and operation of the Tokamak de Varennes. See Fig. 1 for a montage of some of these developments.

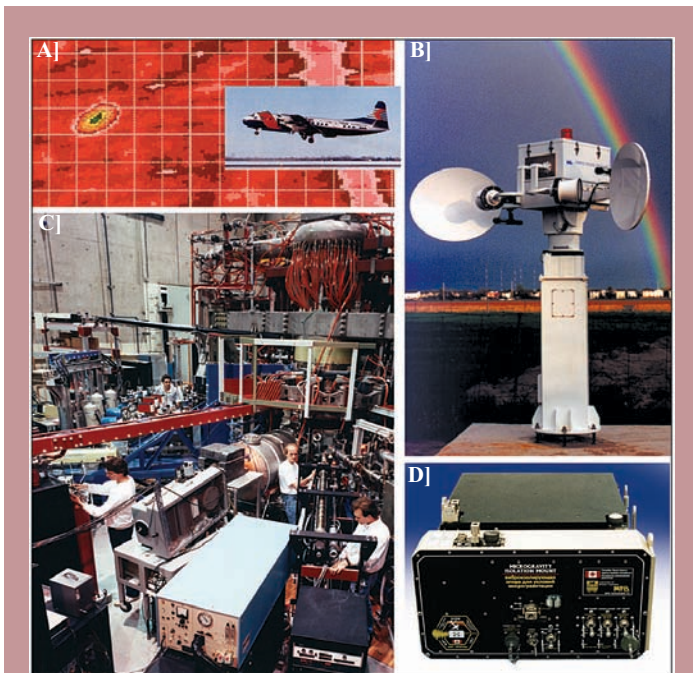

Figure 1: Major developments by MPB in the earlier years: A) Airborne Imaging Microwave Radiometer (AIMR); B) Radarsat 1 Telemetry Calibration Transponder; C) Tokamak de Varennes Experimental Facility; D) Microgravity Isolation Mount (MIM) built for the Canadian experiment on the MIR space station.

Amongst the initial products of the Company were the VISTA 80 graphics generator used by the CBC to first display and telecast evolving election results, and a long life sealed-off carbon dioxide laser with incredible stability making it particularly suitable for spectroscopic investigations. This was followed by the introduction of low cost, no frills excimers, including the smallest size excimer laser available. These excimer lasers remain a MPB product even today. (See Fig. 2)

2. Pioneering optical fibre telecommunications

An opportunity for MPB to enter the, then, new field of optical fibre telecommunications arose in 1987. An international consortium consisting of AT&T, British Telecom, France Telecom and Teleglobe Canada made the decision to develop and deploy the first ever trans-Atlantic

By *Morrel P. Bachynski LFIEEE*

President and Founder, MPB Technologies Inc.

Abstract

A brief account of the 30-year history of MPB Technologies Inc. is outlined. Major emphasis is on the Company developments in optical fibre telecommunications and photonic devices. These include: the first commercial trans-Atlantic optical fibre telecommunications system, the evolution of the Super Raman concept leading to long unrepeated optical telecom spans greater than 500 km, and the associated high performance modules which have made this possible. As a consequence, MPB telecom equipment, manufactured in Montreal, is now found on every continent of the world except Antarctica. Finally, recent, on-going developments are described, including high power, cw, visible (green, yellow, orange) and mode-locked fibre lasers designed for application to medical and industrial markets.

Sommaire

Un bref compte-rendu historique des 30 ans de MPB Technologies Inc. est fourni. L'attention principale porte sur les développements de la firme dans les télécommunications à fibres optiques et les composantes photoniques: le premier système de télécommunications à fibre optique transatlantique, et l'évolution du concept Super Raman rendant possibles des portées optiques de plus de 500 km sans répéteurs. En conséquence les équipements de MPB Télécom, fabriqués à Montréal, se trouvent maintenant sur tous les continents (sauf l'Antarctique). Enfin, de récents développements en cours sont dépeints, incluant des lasers photoniques à modes synchronisés, onde continue, et haute puissance dans le spectre visible (vert, jaune, orange) pour applications médicales et industrielles.



Figure 2: MPB products primarily from the earlier years: A) Early MPB lasers: mini-excimer and CO₂; B) VISTA 80 graphics generator for television broadcasting; C) Freedom 7 force feedback hand controller (present).

optical fibre system to carry commercial communications traffic between North America and Europe.

A need arose for the system to have the ability to switch traffic on demand between landing points in the USA, Canada, United Kingdom, France and Spain. The driver behind this requirement was to optimize traffic, particularly due to the increased traffic to Spain for the 1992 Barcelona Summer Olympic Games and the subsequent reduction of traffic in the Spanish branch following the Olympics. It is important to note that at the time, there had never been an optical fibre link across the Atlantic—or any other ocean—as the first experimental system (TAT-8) was implemented one full year later in 1988.

The requirements of the system for the “Undersea Branching Multiplexers” (UBMs) included using a number of infant emerging technologies, namely:

- first solid state laser operating at a wavelength of 1.5μ ,
- digital line bit rates at twice the previous speed ever used (could ASICs be designed and qualified for this bit rate?),
- block-interleaving modulation to switch blocks of traffic,
- and mechanical, moisture-proof packaging to withstand an ocean depth of 10,000 meters.

Furthermore, the units had to be designed for a reliability of 25 years with only *one* failure permitted for the three UBM units comprising the system in this time frame. Such a unit had previously never been even designed in theory, let alone any experimental or breadboard work. Not knowing that these requirements were nearly impossible to meet, MPB bid on the supply of the UBMs and the associated supervisory and terminal equipment. How MPB was awarded the contract (eight times the annual business volume of the Company at the time) by the international consortium to research and develop the UBMs and associated terminal equipment, manufacture five units (two of which were spares), install the associated terminal equipment in the five countries (USA, United Kingdom, France, Spain and Canada), assist with the trans-Atlantic laying of the UBMs, as well as training, service and warranty, is a saga that could form a mystery novel.

Suffice to say, MPB assembled their best engineers and scientists as a core and augmented them with recent graduates from Canadian universities. The Scientific Authority for the project were Bell Labs—the renown gurus of R&D in communications, a challenging baptism for MPB’s nervous personnel, new to the optical fibre telecommunications field. The R&D started in the first quarter of 1987 and on August 21, 1991, the first UBM was spliced in and laid on the North American side of the Atlantic Ocean with completion of the trans-Atlantic installation by the end of the year. Three engineering members of the MPB team were aboard the ocean vessels laying the UBMs—a unique experience, surpassed only by a flight in space or a walk on the moon. Following several months of commissioning, the TAT-9 system went into commercial

operation on March 2, 1992. During the lifetime of the TAT-9 system (14 years), not a single failure was attributed to the equipment developed and built by MPB. See Fig. 3 for scenes from the UBM activities.

3. Dilemma of an encore

Following TAT-9, the dilemma for MPB was how to remain in the telecom major leagues. Taking on the telecom giants directly would be business suicide. Finding a niche where these giants would become MPB’s customers was the challenge. Such a niche painstakingly emerged, starting with a 280 km repeaterless link between Crete and the mainland of Greece for which MPB designed and supplied the key equipment. This was followed by four links for the Philippines Long Distance network, then some links for the Trans-Asia-Europe network and finally, a major 323 km repeaterless link for the Communications Authority of Thailand. Thus, the area of telecom equipment for long, unrepeated optical fibre links (both undersea and terrestrial) became the MPB niche.

This niche offered the opportunity to add associated telecom modules (transmitter/modulators, pre-amplifiers, power amplifiers, forward error correction, remote optical power amplifiers and network management software) so as to have a complete terminal solution to interface with the transport telecom equipment of the major telecom system suppliers. In order to meet the ever increasing demand for longer repeaterless span lengths, all of these modules have to be of the highest performance permitted by the state of technology at the time. This also permitted MPB, based on this technology, to offer high performance, stand alone modules and bench top instruments.

4. The Super Raman and beyond

In parallel with these developments, research at MPB focused strongly on the use of Raman amplification in efforts to extend the span lengths. The subsequent discovery of “Super Raman” amplification and the application of higher order Raman pumping (which was awarded world-wide patents as well as a Photonics Circle of Excellence recognition) permitted MPB to extend their long span offering by more than 9.5 dB and jump ahead as a supplier of choice for this class of equipment. See Fig. 4 for typical MPB terminal equipment for repeaterless links.

Development of this business niche progressed well for MPB even into August, 2001 which was during the initial days of the “burst of the telecom bubble” when the unprecedented growth in telecom capacity had far surpassed the immediate demand. Then came the 9/11 incident with the two planes deliberately targeting the New York World Trade Centre Towers. Following this date, the world stood largely still as far as international telecom sales was concerned, with the downturn continuing through into 2002. However, through frugality MPB was able to drag itself into the financial “black” during 2003, where it continues to remain today.

In hindsight, the telecom meltdown helped establish MPB as a major supplier in the optical fibre repeaterless-span area of the market. As the major telecom giants cut costs and reduced staff, they turned more and more to MPB as their supplier for this niche. This has forced MPB to accelerate its R&D program to add ultra-high performance modules to augment the advantages of its Raman products. These have included Erbium-Doped Fibre Amplifiers (EDFA) with noise figures as low as 3.2 dB, power levels to 34 dBm, flat gain, wide bandwidths in both the C-band (1527 – 1567 nm) and L-band (1603 – 1638 nm), electronic transient control and miniature (credit card) size. See Fig. 5 (next page) for examples of typical MPB module products.

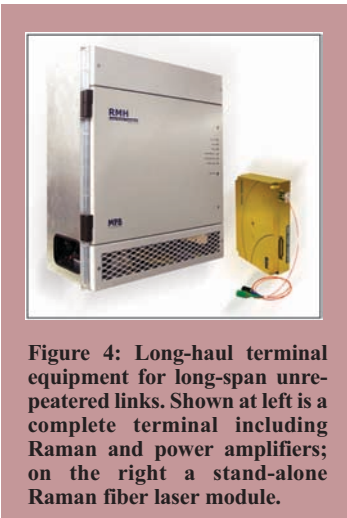

Figure 4: Long-haul terminal equipment for long-span unrepeated links. Shown at left is a complete terminal including Raman and power amplifiers; on the right a stand-alone Raman fiber laser module.

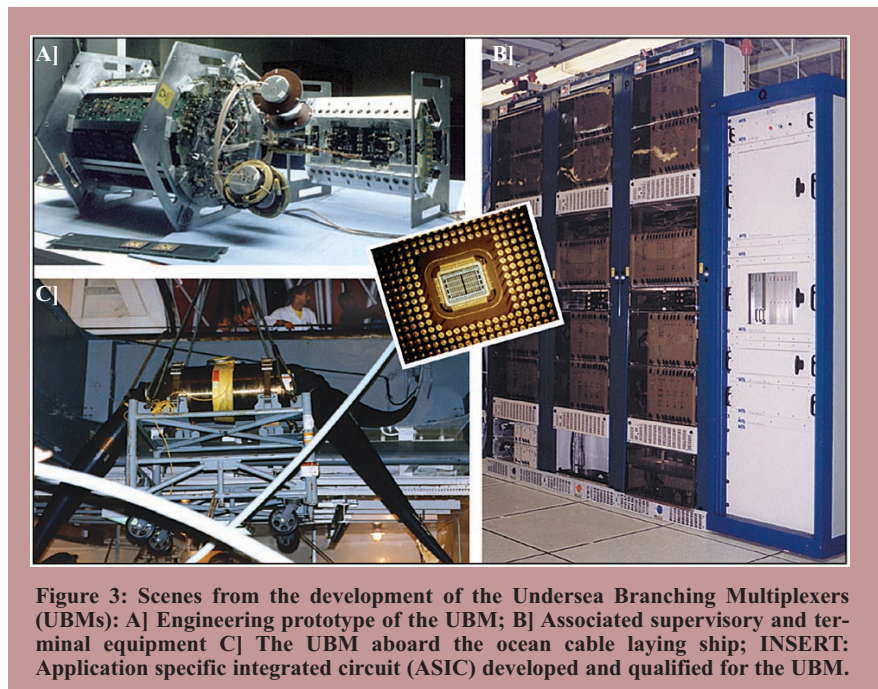

Figure 3: Scenes from the development of the Undersea Branching Multiplexers (UBMs): A] Engineering prototype of the UBM; B] Associated supervisory and terminal equipment C] The UBM aboard the ocean cable laying ship; INSERT: Application specific integrated circuit (ASIC) developed and qualified for the UBM.



Figure 5: Various high performance erbium-doped fibre (EDF) instruments (amplifiers, broadband sources, combosources) and amplifiers developed and manufactured by MPB.

This demand for ultra-high performance products has fitted well into the MPB culture which throughout its history has nourished a very high scientific content with a practical utility to satisfy the requirements of the market.

The need and desire to be one of the best in the world is a given in the operating philosophy of the Company. This has led to a number of international collaborations and joint publications with renown organizations including Alcatel (France), Tycom (USA), Deutch Telecom (Germany) and Sumitomo (Japan).

Today, MPB-developed optical fibre telecom equipment permits unrepeated spans in excess of 500 km (overcoming greater than 100 dB of losses) and is deployed extensively throughout the world. More than 95% of MPB's business volume arises from export sales outside of Canada. This is illustrated in Fig. 6 which shows the countries in the world where MPB products are successfully operating.

5. New directions

The recent worldwide strong interest in fibre lasers and their numerous applications have stimulated MPB to move into this field in a major way. The MPB proprietary Raman amplification is based on Raman fibre lasers so the technological base existed to readily move into fibre lasers in general. The key developments are twofold: namely, fibre lasers operating in the visible region of the spectrum targeting medical applications and modelocked fibre lasers with related amplifiers to address micro-processing and micromachining needs.



Figure 6. World map showing countries where MPB products are deployed. (~95% of sales are exported.)

Fibre lasers in the visible band have been developed in the green (560 nm), yellow (580 nm) and orange (594 nm). These offer output powers in excess of two watts with a polarized, near diffraction limited beam. Collaborative experiments with the yellow and orange lasers have been conducted with the National Institutes of Health (USA) resulting in several joint publications. Mode locked fibre lasers have been developed in the erbium band (1530 -1565 nm) and in the ytterbium (1020 – 1100 nm) bands. On-going investigations address a variety of applications in collaboration with prospective customers. Typical fibre lasers developed by MPB are shown in Fig. 7

There are demands for MPB's high-reliability optical fibre products for application to the exploration of outer space. An EDFA from MPB has already successfully flown on a balloon mission. More recently, an optical fibre sensor and fibre laser have been designed, built, qualified and integrated as part of the payload for the PROBA mission of the European Space Agency scheduled for launch in late 2007 or early 2008.

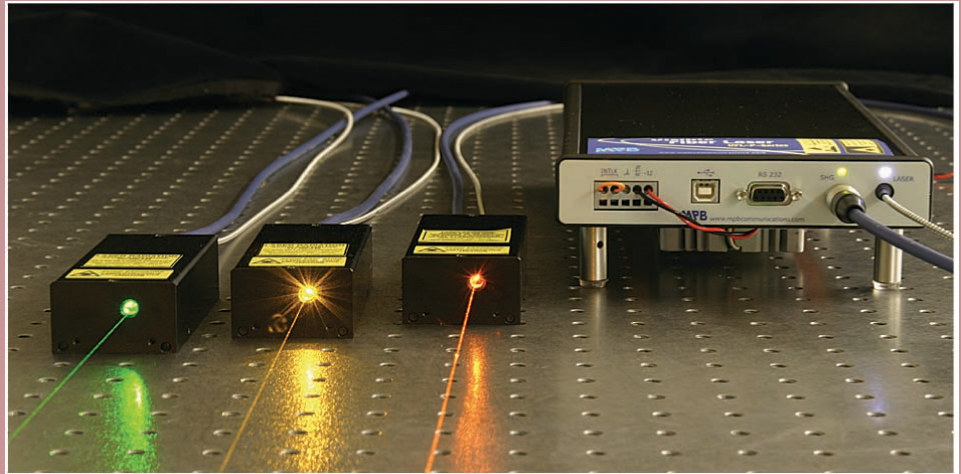

Figure 7: Recent MPB developments in fibre lasers operating in the visible spectral range (green, yellow, orange).

6. Conclusion

Born during the administrations of Jimmy Carter in the USA, Pierre Elliott Trudeau in Canada and René Lévesque in Quebec, MPB has weathered numerous economic, political and fiscal challenges. The Company has enjoyed continued success without resorting to venture capital investment or bank debts, which MPB attributes to the caliber of talented individuals who continue to be attracted to participate in and contribute to this enterprise. Today, the Company is positioned, better than ever before, to continue its legacy of innovation and meet the demands of the world market.

About the Author

Morrel P. Bachynski is a graduate in Engineering Physics from the University of Saskatchewan where he also obtained his Masters Degree in physics. His PhD was earned in physics at McGill University. He is co-author of the book "The Particle Kinetics of Plasmas" and the author of more than 90 publications in recognized scientific journals.



Dr. Bachynski is a Fellow of the Royal Society of Canada, the American Physical Society, the Institute of Electrical and Electronic Engineers, the Canadian Academy of Engineering (serving as President during 2003/04) and a Honorary Member of the Engineering Institute of Canada. His awards include the Prix Scientifique du Québec, the Queens Silver Jubilee Medal, the CAP Medals for Achievement in Physics and for Industrial and Applied Physics, the Canada Award for Business Excellence – Entrepreneurial Gold, the Prix Lionel Boulet, the Royal Society of Canada Thomas W. Eadie Medal and Honorary Degrees from the Universities of Waterloo, McGill and Concordia.

Patenting Software Innovations:

A brief overview of the situation in some jurisdictions of interest

1.0 Introduction

Recent developments in patent law and jurisprudence have rendered possible patent protection for innovations related to software in many jurisdictions worldwide.

This is welcomed since the protection of Intellectual Property is desirable in a context of globalization.

2. The issue of defining a “software patent”

There are various definitions for a “software patent”. However it seems that the scope of the definition varies greatly depending on who is giving the definition. Accordingly, a first task is to try therefore to better define this term.

According to Encyclopedia Britannica¹, software relates to “instructions that tell a computer what to do. Software comprises the entire set of programs, procedures, and routines associated with the operation of a computer system”.

Since software comprises “programs, procedures, and routines”, it is dealing more generally with “data”, which is the common denominator of “programs, procedures, and routines”. A “software patent” can therefore be defined as a patent for an innovation related to any operation or combination of operations involving data.

The basic operations involving data may comprise for instance at least one of the following operations:

1. A modification of data. An example of an innovation involving modification of data is for example an algorithm for an innovative method for compressing data according to a given protocol. For instance, US Patent 7,249,153 relates to a “Data compression using Chebyshev transform”.
2. A transmission of data. An example of an innovation involving the transmission of data is for example an innovative method for transmitting data over a packet-switched network. For example US Patent No 7,248,588 relates to a “Method for transmitting data packets and network element for carrying the method”.
3. Collection of data. An example of an innovation involving the collection of data is for example an innovative method for acquiring data. For example US Patent No 7,181,412 discloses “Systems and methods for collecting consumer data”.
4. Display of data. An example of an innovation involving the display of data is for example an innovative method for displaying objects on a display unit. For example US Patent No. 7,246,323 discloses “Displaying information to indicate both the importance and the urgency of the information”.
5. Sorting of data. An example of an innovation involving sorting of data is for example an innovative method for indexing data according to linguistic criteria. US Patent No 7,249,121 discloses for instance “Identification of semantic units from within a search query”.
6. Use of data. An example of an innovation involving the use of data is for example a method for playing a game. US Patent No 7,233,338 discloses for instance a “Computer program product and computer system”.

A “software patent” can therefore be defined as a patent for an innovation related to at least one of the above-identified operations of data.

Below, the patenting of software innovations respectively in Canada, in the United States of America and in Europe will be discussed.

3. Patenting software innovations in Canada

In Canada, Section 2 of the Patent Act defines the patentable subject matter and reads, “‘invention’ means any new and useful art, process, machine, manufacture or composition of matter, or any new and useful improvement in any art, process, machine, manufacture or composition of matter”². An “art” is an act or series of acts performed by some physical agent upon some physical object and producing in that object some change of either character or condition.

By Alexandre Abecassis

Fasken Martineau DuMoulin LLP

The Supreme Court stated in *Shell*³ that the term “art” must be given its general connotations of being learning or knowledge as commonly used in expressions such as “the state of the art” or “prior art”, the Court emphasized⁴ that an “art” had to have a method of practical application. The Court also stated⁵ that the Exchequer Court (in *Tennessee Eastman*) had affirmed that “art” was a word of very wide connotation and was not to be confined to processes or products or manufacturing techniques but extended as well to new and innovative methods of applying skill or knowledge provided they produced an economic result in relation to trade, commerce or industry.

Subsection 27(8) of the Patent Act⁶ further discloses, “No patent shall be granted for any mere scientific principle or abstract theorem”. It is therefore not possible to obtain a patent protection for a formula *per se*.

Moreover, it has been stated by the Canadian Patent Office⁷ that “Software in the form of a *data model* or an *algorithm* is automatically excluded from patentability under subsection 27(8) of the Patent Act, in the same manner as a mathematical formula, and is considered to be equivalent to a mere scientific principle or abstract theorem.” (emphasis added).

It therefore appears that an algorithm *per se* is excluded from patentable subject matter. An algorithm in a software innovation is accordingly excluded from patentability *de jure*.

It is further disclosed in the Manual of Patent Office Practice (MPOP)⁸ that “claims consisting solely of code listings are not patentable. Software expressed as lines of code or listings may be protected as literary works under the Copyright Act.”

In fact, the Manual of Patent Office Practice (MPOP) discloses⁹ that :

“For a method to be considered an art under section 2 of the Patent Act, the method must be:

- A. an act or series of acts performed by some physical agent upon some physical object and producing in such object some change either of character or of condition; and
- B. it must produce an essentially economic result relating to trade, industry or commerce”.

The Manual of Patent Office Practice (MPOP) therefore indicates that in Canada the above-defined two-pronged test has to be used in order to assess if a claim has patentable subject matter in the sense of Section 2 of the Patent Act. Of course, this is not the only requirement to meet in order to become patentable subject matter¹⁰.

Moreover, in Canada it is possible to protect a software innovation using various types of claims provided that they meet the above-mentioned test. For instance, a claim for a process or method claim may be allowable in Canada. The claim for the process or method is used to protect a sequence of steps achieved by and defining the software innovation. A claim for an apparatus claim may further be allowable. The apparatus claim can be used for instance to claim a combination of modules interacting in the software innovation. A claim for a product or a medium claim may be considered allowable. The product or medium claim is used to protect a product or a medium comprising instructions, such as a storage device, which when executed perform the software innovation. Finally, a signal claim and a data structure claim may be allowable in Canada. The signal claim is used to protect a signal which when received performs the software innovation while the data structure claim is used to protect a data structure used or created by the software innovation.

Canada therefore offers a broad protection for software innovation provided those innovations falls within the two-pronged test.

4. Patenting software innovations in the U.S.

Under Article I, Section 8 of the Constitution, Congress has enacted laws to protect the discoveries of the inventors: “Congress shall have power

... to promote the progress of science and useful arts, by securing for limited times to authors and inventors the exclusive right to their respective writings and discoveries". These patent laws are contained primarily in Title 35 of the United States Code.

Section 101 of Title 35 U.S.C. sets out the subject matter that can be patented and reads

"Section 101. Inventions patentable:

Whoever invents or discovers any new and useful process, machine, manufacture, or composition of matter, or any new and useful improvement thereof, may obtain a patent therefor, subject to the conditions and requirements of this title [35 USC Section 1 et seq.]".

Software innovations do not seem therefore to be excluded *de jure* from patentability.

However, the Courts cases throughout the years have given an indication on what is and what is not patentable.

In 1972, The United States Supreme Court held in *Gottschalk v. Benson*¹¹ that a computer program on a numerical algorithm was not patentable if "the patent would wholly pre-empt the mathematical formula and in practical effect would be a patent on the algorithm itself". More precisely, it was disclosed "It is conceded that one may not patent an idea. But in practical effect that would be the result if the formula for converting BCD numerals to pure binary numerals were patented in this case. The mathematical formula involved here has no substantial practical application except in connection with a digital computer, which means that if the judgment below is affirmed, the patent would wholly pre-empt the mathematical formula and in practical effect would be a patent on the algorithm itself."

In 1981, the United States Supreme Court held in *Diamond v. Diehr*¹² that it was possible to claim a process comprising the use of a formula. "Our earlier opinions lend support to our present conclusion that a claim drawn to subject matter otherwise statutory does not become nonstatutory simply because it uses a mathematical formula, computer program, or digital computer." and that the claims should be considered as a whole: "In determining the eligibility of respondents' claimed process for patent protection under 101, their claims must be considered as a whole. It is inappropriate to dissect the claims into old and new elements and then to ignore the presence of the old elements in the analysis."

The core of the case had to do with the process of curing synthetic rubber, which is dependent on a number of factors including time, temperature and thickness of the mold. The problem was that there was, at the time the invention was made, no way to obtain an accurate measure of the temperature without opening the press. Using the Arrhenius equation $\ln(v)=CZ+x$ it is possible to calculate when to open the press and remove the cured, molded rubber (variables and constants identified in legal claim below as indicated by double indented section).

The invention claimed solved this problem by constantly checking the temperature, feeding the measured values into a computer and using the Arrhenius equation in the computer to calculate when the molding machine should open the press.

One of the claims allowed was for:

"A method of operating a rubber-molding press for precision molded compounds with the aid of a digital computer, comprising:

- providing said computer with a data-base for said press including at least, natural logarithm conversion data (\ln), the activation energy constant (C) unique to each batch of said compound being molded, and a constant (x) dependent upon the geometry of the particular mold of the press,
- initiating an interval timer in said computer upon the closure of the press for monitoring the elapsed time of said closure,
- constantly determining the temperature (Z) of the mold at a location closely adjacent to the mold cavity in the press during molding,
- constantly providing the computer with the temperature (Z),
- repetitively performing in the computer, at frequent intervals during each cure, integrations to calculate from the series of temperature determinations the Arrhenius

equation for reaction time during the cure, which is $\ln(v)=CZ+x$, where v is the total required cure time,

- repetitively comparing in the computer at frequent intervals during the cure each said calculation of the total required cure time calculated with the Arrhenius equation and said elapsed time, and
- opening the press automatically when a said comparison indicates completion of curing."

In 1998, the United States Court of Appeals for the Federal Circuit judged a landmark case in patent law in *State Street Bank & Trust Company v. Signature Financial Group, Inc.*¹³.

This case stemmed from a dispute between these two Boston-based financial institutions, which both act as custodians and accounting agents for multi-tiered partnership fund financial services. Signature Financial Group had acquired U.S. patent 5,193,056.

The patent disclosed: "A data processing system is provided for monitoring and recording the information flow and data, and making all calculations, necessary for maintaining a partnership portfolio and partner fund (Hub and Spoke) financial services configuration". The "spokes" were mutual funds that pool their assets in a single portfolio or "hub" for tax and administrative reasons.

The software performed real-time calculations to allocate income, gains, losses and expenses among each fund and record daily changes in assets and market prices. State Street Bank challenged the patent in court, after Signature Financial Group refused to license it to its rival.

In March 1996, the district court ruled that patent 5,193,056 was invalid and applied the *Freeman-Walter-Abele*¹⁴ test for reaching its conclusion, articulated as:

"First, the claim is analyzed to determine whether a mathematical algorithm is directly or indirectly recited. Next, if a mathematical algorithm is found, the claim as a whole is further analyzed to determine whether the algorithm is 'applied in any manner to physical elements or process steps,' and, if it is, it 'passes muster under Section 101.'"

In July 1998, the appeals court hearing the *State Street*¹⁵ case reversed the lower court, and held that Signature's software was, in fact, eligible for a patent.

The court stated that:

"After *Diehr* and *Chakrabarty*, the *Freeman-Walter-Abele* test has little, if any, applicability to determining the presence of statutory subject matter. As we pointed out in *Alappat*¹⁶, application of the test could be misleading, because a process, machine, manufacture, or composition of matter employing a law of nature, natural phenomenon, or abstract idea is patentable subject matter even though a law of nature, natural phenomenon, or abstract idea would not, by itself, be entitled to such protection. The test determines the presence of, for example, an algorithm. Under *Benson*, this may have been a sufficient indicium of non-statutory subject matter. However, after *Diehr* and *Alappat*, the mere fact that a claimed invention involves inputting numbers, calculating numbers, outputting numbers, and storing numbers, in and of itself, would not render it non-statutory subject matter, unless, of course, its operation does not produce a 'useful, concrete and tangible result.'"¹⁷

The court held that:

"(...) the transformation of data, representing discrete dollar amounts, by a machine through a series of mathematical calculations into a final share price, constitutes a practical application of a mathematical algorithm, formula, or calculation, because it produces 'a useful, concrete and tangible result'—a final share price momentarily fixed for recording and reporting purposes and even accepted and relied upon by regulatory authorities and in subsequent trades."¹⁸

This decision stated that once the subject matter is reduced to some type of practical application, it becomes patentable subject matter.

The standard for this practical application has been, and remains, the production of "a useful, concrete and tangible result"¹⁹. The Federal Circuit in *State Street*²⁰ holds that the production of "a final share price momentarily fixed for recording and reporting purposes and even accepted and relied upon by regulatory authorities and in subsequent trades,"²¹ is indeed the production of a "useful, concrete and tangible result".

The Federal Circuit held that once an invention passes the utility requirement, that invention becomes eligible under Section 101. However, "Section 101 specifies that statutory subject matter must also satisfy the other 'conditions and requirements' of Title 35, including novelty, nonobviousness, and adequacy of disclosure and notice."²²

The Federal Circuit also held that business methods are no longer an exception to statutory subject matter. Instead, business methods are subject to the same legal requirements for patentability as applied to any other process or method.

The court concluded that the question of statutory subject matter "should not focus on which of the four categories of subject matter a claim is directed to—process, machine, manufacture, or composition of matter—but rather on the essential characteristics of the subject matter, in particular, its practical utility" which is further defined as producing "useful, concrete, and tangible result.". These results can be measured in numerical terms such as "as price, profit, percentage, cost, or loss."²³ The court stated that "Since the 1952 Patent Act, business methods have been, and should have been, subject to the same legal requirements for patentability as applied to any other process or method."²⁴

It therefore becomes clear from this decision that if a software innovation produces a "useful, concrete and tangible result", it qualifies for patent protection. This decision has further included business method in the patentable subject matter.

As in Canada, it is possible to protect software innovations using various types of claims. More precisely, a process or method claim, an apparatus claim, a product or medium claim and a signal claim may be used to protect an aspect of a software innovation.

It will be however appreciated that the scope of what can be protected in the United States is much larger than the scope of what can be protected in Canada since the threshold of producing a "useful, concrete and tangible result" is much easier to reach than the two-pronged test used in Canada. Accordingly, filing a patent application in the United States for a software innovation is to be seriously considered. Applicants should know, however, that there is a real issue of backlog at the United States Patent and Trademark Office for these types of innovations. The Applicants have now to wait for many years before an office action issues.

5. Patenting software innovations in Europe

In Europe, the Convention on the grant of European patents of October 5, 1973, also referred to as "European Patent Convention", instituted the European Patent Organisation (EPO) and provides a legal system according to which European patents are granted.

Although the term "European patent" is used to refer to patents granted by the EPO, after the grant such a patent is not a unitary right. It has to be validated in countries, contracting states of the EPO, where patent protection is ultimately sought. A European patent may be subject to revocation and/or narrowing pursuant a time-limited, unified, post-grant opposition procedure.

Patentable inventions are defined in Article 52 of the European Patent Convention which states:

"Article 52

(1) European patents shall be granted for any inventions which are susceptible of industrial application, which are new and which involve an inventive step.

(2) The following in particular shall not be regarded as inventions within the meaning of paragraph 1:

- (a) discoveries, scientific theories and mathematical methods;
- (b) aesthetic creations;
- (c) schemes, rules and methods for performing mental acts, playing games or doing business, and programs for computers;
- (d) presentations of information.

(3) The provisions of paragraph 2 shall exclude patentability of the subject-matter or activities referred to in that provision only to the extent to which a European patent application or European patent relates to such subject-matter or activities as such.

(4) Methods for treatment of the human or animal body by surgery or therapy and diagnostic methods practised on the

human or animal body shall not be regarded as inventions which are susceptible of industrial application within the meaning of paragraph 1. This provision shall not apply to products, in particular substances or compositions, for use in any of these methods."

Art. 52(2)(c) therefore seems to exclude "programs for computers" from patentability. In fact, the exclusion for the patentability of the subject-matter applies to the extent to which a European patent application or European patent relates to the subject-matter as such (Art. 52(3) EPC). It therefore does not mean that all inventions including some software are not patentable.

The Guidelines for Examination issued by the EPO²⁵ states:

2.3.6

Programs for computers

Programs for computers are a form of "computer-implemented invention", an expression intended to cover claims which involve computers, computer networks or other conventional programmable apparatus whereby prima facie the novel features of the claimed invention are realised by means of a program or programs. Such claims may e.g. take the form of a method of operating said conventional apparatus, the apparatus set up to execute the method, or, following T 1173/97 (OJ 10/1999, 609), the program itself. Insofar as the scheme for examination is concerned, no distinctions are made on the basis of the overall purpose of the invention, i.e. whether it is intended to fill a business niche, to provide some new entertainment, etc.

The basic patentability considerations here are in principle the same as for other subject-matter. While "programs for computers" are included among the items listed in Art. 52(2), if the claimed subject-matter has a technical character it is not excluded from patentability by the provisions of Art. 52(2) and (3). However, a data-processing operation controlled by a computer program can equally, in theory, be implemented by means of special circuits, and the execution of a program always involves physical effects, e.g. electrical currents. According to T 1173/97, such normal physical effects are not in themselves sufficient to lend a computer program technical character. But if a computer program is capable of bringing about, when running on a computer, a further technical effect going beyond these normal physical effects, it is not excluded from patentability, irrespective of whether it is claimed by itself or as a record on a carrier. This further technical effect may be known in the prior art. A further technical effect which lends technical character to a computer program may be found e.g. in the control of an industrial process or in processing data which represent physical entities or in the internal functioning of the computer itself or its interfaces under the influence of the program and could, for example, affect the efficiency or security of a process, the management of computer resources required or the rate of data transfer in a communication link. As a consequence, a computer program claimed by itself or as a record on a carrier or in the form of a signal may be considered as an invention within the meaning of Art. 52(1) if the program has the potential to bring about, when running on a computer, a further technical effect which goes beyond the normal physical interactions between the program and the computer. A patent may be granted on such a claim if all the requirements of the EPC are met; see in particular Art. 84, 83, 54 and 56, and IV, 4.4 below. Such claims should not contain program listings (see II, 4.14a), but should define all the features which assure patentability of the process which the program is intended to carry out when it is run (see III, 4.4, last sentence).

Moreover, following T 769/92 (OJ 8/1995, 525), the requirement for technical character is satisfied if technical considerations are required to carry out the invention. Such technical considerations must be reflected in the claimed subject-matter.

When considering whether a claimed computer-implemented invention is patentable, the following is to be borne in mind. In the case of a method, specifying technical means for a purely non-technical purpose and/or for processing purely non-technical information does not necessarily confer technical character on any such individual step of use or on the method as a whole. On the other hand, a computer system suitably pro-

grammed for use in a particular field, even if that is, for example, the field of business and economy, has the character of a concrete apparatus, in the sense of a physical entity or product, and thus is an invention within the meaning of Art. 52(1) (see T 931/95, OJ 10/2001, 441).

If a claimed invention does not have a prima facie technical character, it should be rejected under Art. 52(2) and (3). In the practice of examining computer-implemented inventions, however, it may be more appropriate for the examiner to proceed directly to the questions of novelty and inventive step, without considering beforehand the question of technical character. In assessing whether there is an inventive step, the examiner must establish an objective technical problem which has been overcome (see IV, 9.8.2). The solution of that problem constitutes the invention's technical contribution to the art. The presence of such a technical contribution establishes that the claimed subject-matter has a technical character and therefore is indeed an invention within the meaning of Art. 52(1). If no such objective technical problem is found, the claimed subject-matter does not satisfy at least the requirement for an inventive step because there can be no technical contribution to the art, and the claim is to be rejected on this ground.

Accordingly and as stated in *Computer-implemented inventions*²⁶ (CII) published by the EPO:

“Accordingly, CII’s can be patented if:

- They have technical character and solve a technical problem.
- They are new.
- They involve an inventive technical contribution to the prior art.”

It is further stated²⁷:

“Let us demonstrate the effects of CII legislation with some real-life cases. The truth of the matter is this: Inventions that use computer programs to provide a business process—not a technical process—are not patentable.

A patent application for an Internet auction system was not granted because the system used conventional computer technology and computer networks—which meant it made no inventive technical contribution to the level of existing technology. Such a system may provide business advancement to its users, but that is not the type of advancement required by the EPO.

On the flip side, the problem of improving signal strengths between mobile phones is a technical problem, even if it is solved by modifications to the phone software rather than its hardware. Such an invention would obtain a patent, provided that the solution is also novel and inventive.”

It becomes possible to protect a software innovation using various types of claims such as a process or method claim, an apparatus claim, a product or medium claim and a signal claim.

As Canada and the United States it is possible to obtain patent protection for software innovations. However the criteria for patentable subject matter are stronger in this region of the world. The applicants will have to keep in mind that any claim should include a step to produce a tangible result such as a step of “displaying data” so that the outcome of a method claimed has a technical character.

6. Conclusion

Patenting software innovations is therefore achievable in a large variety of jurisdictions of choice thanks to recent evolutions in patent law and jurisprudence.

The applicants should however carefully review or have reviewed their patent applications in general and their claims in particular so that the patentability of their software innovations is not compromised.

When the Applicants intend to file in various jurisdictions and file to that extent a first patent application to create a priority date and later on file an International application (PCT) or perform a direct filing in another country, the applicants should pay attention that a proper disclosure is initially present in order to be able to support any amendments to the claims.

Moreover, following the *Festo*²⁸ case, some patent practitioners even advise clients to file a first patent application in the US and another

patent application the same day in another jurisdiction, such as Canada for instance, from which future patent applications will claim priority of. Such approach is used to avoid the court from limiting the scope of interpretation of the claims of a US Patent based on the foreign filing performed or amendments performed during the course of the prosecution following those foreign filings.

It will also be appreciated that care should also be exercised in order to select carefully jurisdictions to use for patenting in order to achieve a valuable patent filing process. For instance, the “litigation-friendly” aspect of a jurisdiction should be considered when choosing a jurisdiction²⁹.

7. References

- [1.] "software" Britannica Concise Encyclopedia. Encyclopædia Britannica, Inc., 2006. Answers.com 11 Jun. 2007. <http://www.answers.com/topic/computer-software>
- [2.] Patent Act, Section 2
- [3.] 67 C.P.R. 2nd 1 at 10-11
- [4.] Id, at 11, 14
- [5.] Id, at 15
- [6.] Patent Act
- [7.] February 2005 a chapter in its Manual of Patent Office Practice (MOPOP) dedicated to “Computer implemented inventions”
- [8.] Id, at 12.04.05
- [9.] Id, at 16.03.02
- [10.] A proper patent application has to be timely filed and each claim must be useful, novel and non-obvious (see Inter alia Sections 27, 28.2, 28.3 of the Patent Act)
- [11.] *Gottschalk v. Benson*, 409 U.S. 63 (1972)
- [12.] *Diamond v. Diehr*, 450 U.S. 175 (1981)
- [13.] *State Street Bank & Trust Co v. Signature Financial Group Inc*, 149 F.3d 1368 (Fed. Cir. 1998), 47 USPQ2d 1596
- [14.] See *In re Freeman*, 573 F.2d 1237 (C.C.P.A. 1978); *In re Walter*, 618 F.2d 758 (C.C.P.A. 1980); *In re Abele*, 684 F.2d 902 (C.C.P.A. 1982)
- [15.] See *Supra* note 13
- [16.] *Alappat*, 33 F.3d at 1543, 31 USPQ2d at 1557
- [17.] Id, at 1544
- [18.] *State Street Bank & Trust Co v. Signature Financial Group Inc*, 149 F.3d at 1373
- [19.] See *Supra* note 17
- [20.] See *Supra* note 13
- [21.] See *Supra* note 18
- [22.] Id, at 1372
- [23.] *Ibid*
- [24.] *Ibid*
- [25.] http://www.european-patent-office.org/legal/guiex/e/c_iv_2_3_6.htm
- [26.] <http://www.epo.org/focus/issues/computer-implemented-inventions.html>
- [27.] *Ibid*
- [28.] *Festo Corp. v. Shoketsu Kinzoku Kogyo Kabushiki Co.*, 535 U.S. 722 (2002)
- [29.] See “The ultimate leverage tacticians”, *Managing Intellectual Property*, May 2007

The purpose of this article is to provide a brief overview of the situation in some jurisdictions of interest for patenting software innovations. It reflects the point of view of its author and is not an opinion expressed on behalf of Fasken Martineau DuMoulin LLP. This article is not intended to provide legal advice. Readers should seek out advices on issues specific to it before acting on any information set out in this article.

About the Author

Alexandre Abecassis is a registered US and Canadian Patent Agent and Partner at the firm Fasken Martineau DuMoulin LLP in Montreal.

He is also the *IEEE Canadian Review's* Newslog editor, diligently tracking and reporting on technology developments and business affairs.



Engineering Management: What's New in the Literature?

On: Integrity, Value, Globalization, Resilience, Diversity, and Innovation

by Terrance Malkinson

Governor — Engineering Management Society

- ◆ General Electric has been known for many years as a company that promotes and sustains high performance and integrity. In *Avoiding Integrity Land Mines* (Harvard Business Review; 85(4):100-108; April, 2007; www.hbr.com) Ben Heineman provides insights on how this large multinational company enforces honesty at all levels. The author was chief legal officer at General Electric for nearly 20 years. He describes a set of systems that combine the communication of clear expectations, with oversight, deterrence and incentives. He discusses how seriously the company takes ethical lapses particularly among its senior leaders and how this expectation of total integrity flows throughout the company with uniform standards that anticipate legal developments and stakeholders changing attitudes about corporate accountability. In particular, company business leaders at all levels are accountable for exemplifying and enforcing integrity. The systems described are applicable to all levels of any organization. Corporate social responsibility is increasingly seen as an important business policy. In: *Top 10 Reasons to Do the Right Thing* (Alberta Venture; 11(2):69-71; February, 2007; www.albertaventure.com), Shannon Sutherland describes ten of the most important reasons why companies should bother with corporate social responsibility.
- ◆ Leaders and members of a profession often look inward asking themselves “who are we as professionals?” “What value do we add to society?”; and “What is changing and driving the change?” In *How Professionals Can Add Value to Their Communities and Organizations* (Public Management; 89(2):32-39; March, 2007; www.icma.org/pm) James Keene, et al. discuss practices in local government that add value to their communities and organizations. Conveying to others the value of a profession is crucial to the professions legitimacy which will then lead to respect and trust. Applicable to all professions the authors provide a list of six best practices that define the skills, commitments and goals of local government professional administrators.
- ◆ The April 2007 issue of Inc. Magazine (29(4):88-125; April, 2007; www.inc.com) focuses on globalization for fun and profit. Eleven articles provide insights on why “expanding overseas is your ticket to new markets, new ideas, and a world of adventure.” Many stories of entrepreneurs who have achieved success are provided. A wealth of information on opportunities and obstacles encountered and what they have learned along the way is available to you. An interesting centerfold entitled *The 21st Century Treasure Map* provides insights into where you might look for new business opportunities globally.
- ◆ Many of us take our health for granted however your state of health can change dramatically and unexpectedly. In Harvard Business Review (85(3):125-130; March, 2007; www.hbr.com), Glenn Mangurian discusses his experiences when an injury of the spinal cord suddenly left the lower half of his body permanently paralyzed. He discusses how he overcame this life transforming event and created a new future for himself and what he learned about resilience and leadership. He distinguishes the difference between resilience and toughness and how resilience is about absorbing challenges and rebounding stronger than before. This is one of the key qualities desired in business leaders today.
- ◆ Organizational gender diversity is particularly important in today's world and very important to encourage at the executive level. Three articles recently published on the career advancement of women. In: HR Magazine (*Cultivating Female Leaders*; 52(2): 44-50; February, 2007; www.shrm.org/hrmagazine), Ann Pomeroy discusses how the retail grocery giant Safeway is helping women advance in the company and how this approach has been mutually beneficial. In: Training and Development (*The Invisible Wall*; 61(3): 33-38; March, 2007; www.astd.org/astd/publications/td_magazine), Michael Laff



discusses initiatives that organizations have launched and designed to identify and recruit women for advanced positions in the organization. The authors provide interesting statistics on the current state of gender diversity within organizations. A second article by Pomeroy (*Peak Performances*; HR Magazine; 52(4):49-53; April, 2007; www.shrm.org/hrmagazine) discusses the issues from the human resource perspective.

- ◆ Today's global environment values employees who are innovative and creative. These types of individuals often are very independent and their values and the way they do their work may cause conflicts with managers who do not fully understand their personalities. In: *Bridging the Gap Between Stewards and Creators* (MIT Sloan Management Review; 48(2):29-36; Winter, 2007; sloanreview.mit.edu/smr/), Robert Austin and Richard Nolan discuss their research on personalities engaged in the process of technological innovation. Clashes between stewards, who are often managers, and creators, who are generally highly skilled technical employees often occur as a result of misunderstanding. Following a discussion of the issue, the authors provide eight guidelines for reducing the potentially destructive impact of steward-creator conflict. In: *Leading Clever People*, published in Harvard Business Review; (85(3):72-79; March, 2007; www.hbr.com), Rob Goffee and Gareth Jones discuss how to manage people who don't want to be led and who may even be smarter than you. An interesting inset entitled *The Traitorous Eight* provides you with an interesting insight into the leadership practices of William Shockley – co-inventor of the transistor. The author states in the conclusion: “If you try to push your clever people, you will end up driving them away. As many leaders of highly creative people have learned, you need to be a benevolent guardian rather than a traditional boss” (pg 79). And finally in: *How Successful Leaders Think* (Harvard Business Review; 85(6):61-67; June, 2007; www.hbr.com) Roger Martin discusses his research on how an effective leader is an integrative thinker – an individual who can consider various ideas at once and then come up with a new idea that contains elements of each idea but is superior to all.
- ◆ Today's diverse workforce often requires individuals of different generations to work together effectively. This presents many challenges to team members resulting from different values and life experiences. In: *You Raised Them, Now Manage Them*; (Fortune; 155(10):38-46; May 28, 2007; www.fortune.com) Nadira Hira provides you with a “field guide” for attracting, retaining, and leading Generation Y (those born between 1977-1995) employees. In: *The Tethered Generation* (HR Magazine; 52(5): 41-46; May, 2007; www.shrm.org/hrmagazine) Kathryn Tyler discusses how the millennial generation employs technology and the challenges this brings to the workplace. In the same issue, she also discusses how to lead and motivate long-tenured employees in order to challenge them and reduce complacency; see pgs. 55-60 *Leveraging Long Tenure*. And finally in: *Ripping Up the Rules of Management* (Business 2.0; 8(4):60-68; May, 2007; <http://money.cnn.com/magazines/business2>) Susanna Hamner and Tom McNichol provide you with insights of “eleven business leaders who achieved success by zigging while the rest of the world zagged.”

About the Author

Terrance Malkinson is a Governor of the Engineering Management Society, international correspondent for IEEE-USA Today's Engineer Online, editor-in-chief of IEEE-USA Today's Engineer Digest, and editor of IEEE Engineering Management. The author is grateful to the Haskayne School of Business Library at the University of Calgary. He can be reached at malkinst@telus.net.



ICUE '07: Report on 6th International Conference for Upcoming Engineers

This year the 6th annual ICUE was held at Ryerson University May 28 and 29. The conference was well attended and had some very interesting sessions and student presentations. It was generously supported and partly funded by the IEEE Toronto Section.

The conference attracted distinguished speakers from industry who gave enlightening presentations. The keynote speakers were Dr. Savvas Chamberlain, CEO of Dalsa Corporation and Dr. Samuel Zhou, VP of Image Technology at IMAX Corporation. The guest speakers were Vasilis Papanikolaou from Gennum, Shahriar Pezesghi from Analog Devices, Dr. Sudip Misra from Yale University, Dennis Cecic from

By *Vijay K. Sood¹ and Dimitrios Androutsos²*
¹IEEE Canada Secretary, 2006-2007; ²Ryerson University

Microchip Technology, Dennis Woo of Toastmasters International, April Khademi from the University of Toronto and Dr. Lev Kirischian, Dr. Isaac Woungang and Joseph Santarcangelo from Ryerson University.

The total number of people who attended the conference, including speakers and students, was 73. Student participation came from Ryerson University, University of Toronto, McMaster, Windsor, and Dalhousie University.

AWARDS

Design Project Winners

Yaseen Khan, Vaikunthan Krishnapillai, Krishna Jeyakumar: *Smart Wireless Energy Meter*

Manvir Badwal et al.: *Design and Implementation of a Pico-Satellite*

Hector Medina, Michael Gitto, Navin Persad: *Wireless DCC Train Network*

Eric Tran, Jonathan Tzanakakis, and Jason Weinstein: *Wireless Sensor Aggregation System: Physical Performance Monitor*

Alexander Maslej: *Mobile RFID Readers*

William Li, Sophie Lam-Damji, Tom Chau, Darcy Fehlings: *Development of a Virtual Reality Therapy System for Training Fine Motor Skills of Children with Hemiplegic Cerebral Palsy*

Paper Winners

Tahir Jaffer, Christopher Conne and Amin Kalbasi: *Sniffing Robot*

Hamid Rasouli - Multihop Relaying: *A New Dimension in Wireless Communications*

Mohammed Islam: *Grey-Scale Image Segmentation Using Minimum Error Thresholding*

Leo Kant: *Vestibular Rehabilitation using Virtual Reality for Driver Safety*

William Li: *Development of a virtual reality therapy system for training fine motor skills of children with hemiplegic cerebral palsy*

Raymond Phan and Michael Hall: *Hardware Implementation of a Real-Time Audio Scrambler using Matrix Encryption*

There was definitely “something in the air” during this student presentation.

Dubbed the “sniffing robot”, this impressive array of technology samples the atmosphere, analyzes it, and then moves in the direction of the source of the compound of interest — in this case, alcohol. (The alcohol being sprayed from a mister for the demonstration.)

The team envisions similar technology being used in the future to identify those with blood-alcohol levels above the legal limit.

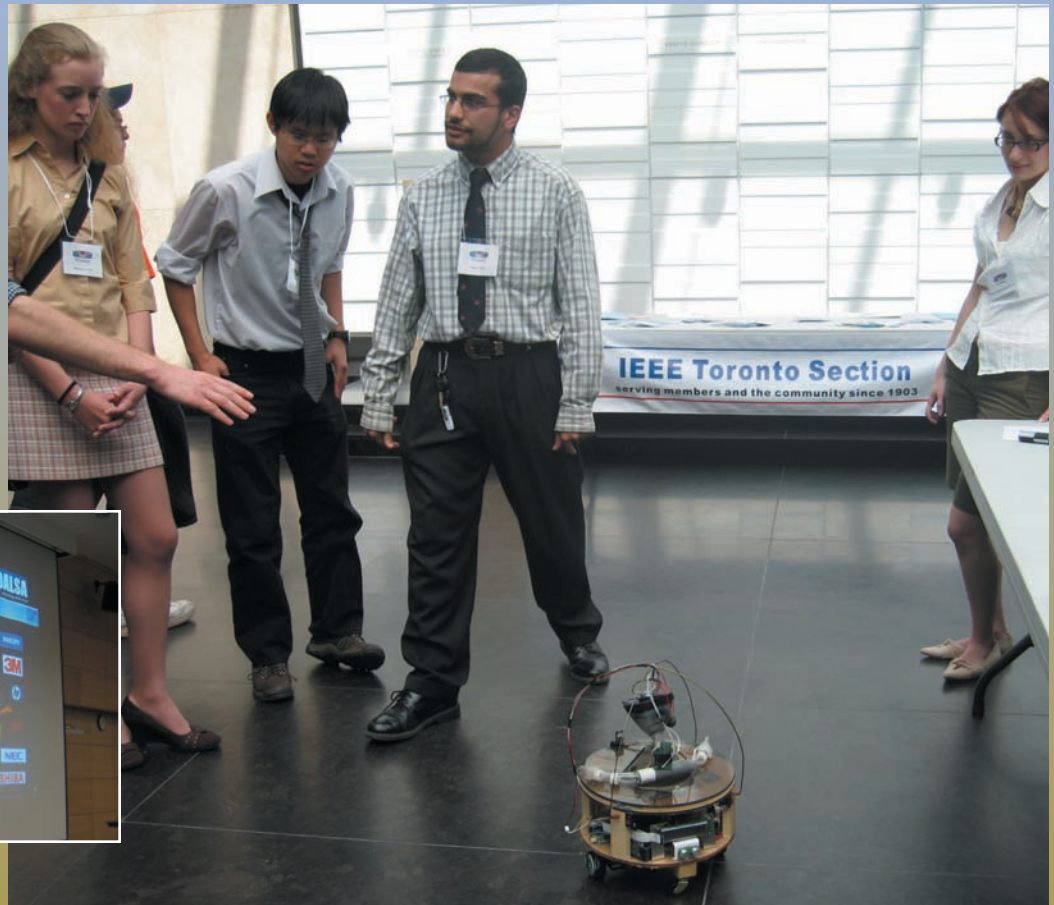

Dr. Savvas Chamberlain, CEO of Dalsa Corporation, explains his industry's supply chain.



Awards Presentation - 23 April 2007 Sheraton Wall Centre Hotel, Vancouver





Canada Area Awards

<p>J.J. Archambault Eastern Canada Merit Award “For meritorious service in eastern Canada at the local IEEE Section and Area Level.”</p>	 <p>Dominic Rivard</p>	<p>Prix de mérite J.J. Archambault de l'est du Canada “pour service méritoire dans l'est du Canada au niveau de la zone et la section locales de l'IEEE.”</p>
<p>M.B. Broughton Central Canada Merit Award “For meritorious service in eastern Canada at the local IEEE Section and Area Level.”</p>	 <p>Vilayil I. John</p>	<p>Prix de mérite M.B. Broughton du centre du Canada “pour service méritoire dans le centre du Canada au niveau de la zone et la section locales de l'IEEE.”</p>
<p>E.F Glass Western Canada Merit Award “For meritorious service in eastern Canada at the local IEEE Section and Area Level.”</p>	 <p>Denard Lynch</p>	<p>Prix de mérite E.F Glass de l'ouest du Canada “pour service méritoire dans l'ouest du Canada au niveau de la zone et la section locales de l'IEEE.”</p>

Service Awards

<p>Wallace S. Read Outstanding Service Award “For outstanding and sustained service to IEEE Canada and the Institute.”</p>	 <p>Celia Desmond</p>	<p>Prix d'excellence de service Wallace S. Read “pour service exceptionnel et soutenu à l'IEEE Canada et à l'Institut.”</p>
<p>Outstanding Engineering Educator Award “For excellence in undergraduate and graduate teaching and student supervision”</p>	 <p>David V. Plant</p>	<p>Prix d'excellence en enseignement du génie “pour contributions exceptionnelles à l'éducation en génie.”</p>
<p>Outstanding Engineer Award “For outstanding contributions to Electrical and Electronics Engineering.”</p>	 <p>Barna Szabados</p>	<p>Prix d'excellence en ingénierie “pour contributions exceptionnelles au génie électronique et électronique.”</p>

Medals

<p>A.G.L. McNaughton Gold Medal “For exemplary contributions to the engineering profession.”</p>	 <p>Raymond D. Findlay</p>	<p>Médaille d'or A.G.L. McNaughton “pour contributions exemplaires à la profession d'ingénieur.”</p>
<p>R.A. Fessenden Medal “For important contributions to the field of telecommunications engineering.”</p>	 <p>Vijay Bhargava</p>	<p>Médaille R.A. Fessenden “pour contributions importantes dans le domaine du génie des télécommunications.”</p>
<p>Power Medal “For important contributions to the field of electrical power engineering.”</p>	 <p>Herman W. Dommel</p>	<p>Médaille en Puissance “pour contributions importantes dans le domaine de l'électrotechnique de puissance.”</p>
<p>Computer Medal “For important contributions to the field of computer engineering and science.”</p>	 <p>Nicolas D. Georganas</p>	<p>Médaille en Informatique “pour contributions importantes dans le domaine du génie informatique et de la science.”</p>

THE IEEE CANADA MAJOR AWARDS PROGRAM AND NOMINATION PROCESS

by Robert T.H. Alden



Awards & Recognition Committee chair Robert Alden (left) and IEEE Canada President Bob Hanna (right) flank 2007 McNaughton Gold Medal winner Raymond Findlay.

The first "Achievement Award", the McNaughton Gold Medal for exemplary contributions to the engineering profession, was established in 1969. The Outstanding Engineer and Outstanding Engineering Educator awards were established in 1994, the Fessenden award in 2000, and two new awards in 2007. The first "Service Award" (Western Canada) was given in 1986, followed by similar awards in Central and Eastern Canada in 1991, and the Canada-wide Outstanding Service Award in 1995. You can view all recipients at www.ieee.ca/awards/recipients.htm.

Nominations are received by the Awards and Recognition Committee (ARC) via web-based forms. The evaluation process starts immediately after the November 30 deadline. ARC

ranks all nominations and submits its recommendations to the IEEE Canada Executive Committee for approval. The President telephones all winners personally and the ARC chair contacts all nominators of unsuccessful nominations. ARC consists of the past chair, geographic and technical area representatives, as well as the past and current (non-voting) president and the chair. Nominations for the 2008 awards are requested — please visit our website at www.ieee.ca/awards/nominations.htm for information and our online web forms.



Vijay Bhargava introduces Raymond Findlay, winner of the 2007 McNaughton Gold Medal, as Mr. Findlay is set to deliver his McNaughton Lecture Address. The address is a highlight of CCECE/CCGEI, given this year during lunch the day after the Awards banquet.

New Developments in Our Awards Program

****your input requested**

Our major awards program is being upgraded to bring it more in line with that of the transnational IEEE awards program. **Step 1** was to add two achievement awards to better balance the breadth of technical disciplines recognized. These were presented for the first time at the recent IEEE Canada Awards Banquet in Vancouver on April 23, 2007; the two new awards are for important contributions in electric power engineering, and in computer engineering and science. They complement the existing award for important contributions in telecommunications engineering and the top award for exemplary contribu-



Bob Hanna presents Md Azizur Rahman with the 2007 Richard Kaufman Award for outstanding contributions in industrial systems engineering. This award first presented in 1988.

tions to the engineering profession. **Step 2** was to redesign all medals for consistency and improved quality. **Step 3** was to develop a higher quality awards brochure (initially presented in Vancouver and available on our web site as a PDF file). **Step 4** is to call for suggestions for individuals to honour by associating their name with each of our yet unnamed medals. Each nominee should be a distinguished Canadian engineer who is considered legendary in the aspect of engineering practice pertaining to that award. **Step 5** is to invite corporations or associations to endow each of our achievement medals.

**** Suggestions for individuals to be honoured on our medals or expressions of interest to endow any of our medals should be sent to the IEEE Canada ARC chair, Robert T.H. Alden at r.alden@ieee.org.**

EAST ...

IEEE Int'l Conference on Systems, Man and Cybernetics (SMC)

2007-10-07...10, Montréal, QC
<http://www.smc2007.org>

41st IEEE Int'l Carnahan Conference on Security Technology

2007-10-08...11, Ottawa, ON
<http://www.carnahanconference.com>

Large Engineering Systems Conference on Power Engineering (LESCOPE)

2007-10-10...12, Montréal, QC
<http://lescope.engineering.dal.ca>

Int'l Workshop on Robotic and Sensors Environments (ROSE)

2007-10-12...13, Ottawa, ON
<http://www.site.uottawa.ca/ROSE2007/>

IEEE Int'l Workshop on Haptic Audio Visual Environments and their Applications (HAVE)

2007-10-12...14, Ottawa, ON
<http://www.discover.uottawa.ca/have2007/>

IEEE FPGA Workshop

2007-10-16...17, Ottawa, ON
<http://ottawa.ieee.ca/ems/fpgaworkshop/>

IEEE Canada Electrical Power Conference (EPC 2007)

2007-10-25...26, Montréal, QC
<http://www.ieee.ca/epc07>

IEEE Biomedical Circuits and Systems Conference - Healthcare Technology (BioCAS)

2007-11-27...30, Montréal, QC
<http://www.biocas2007.org>

3rd Int'l Workshop on Enterprise, Applications and Services in Finance Industry (FinanceCom)

2007-12-08, Montréal, QC
<http://www.financecom.org>

IEEE Int'l Symposium on Technology and Society (ISTAS)

2008-06-26...28, Fredericton, NB
<http://istas08.ca/>

IEEE Int'l Professional Communication Conference (IPCC)

2008-07-14...17, Montréal, QC
<http://www.ieeeeps.org/ipcc2007/>

OCEANS 2008

2008-09-14...19, Québec, QC
<http://www.oceanicengineering.org>

IEEE Sections Congress

2008-09-19...22, Québec, QC
<http://www.ieee.org/sc2008>

WEST ...

IEEE Conference on Electrical Insulation and Dielectric Phenomena (CEIDP)

2007-10-14...17, Vancouver, BC
<http://ewh.ieee.org/soc/dei/ceidp/ceidp2007.htm>

5th Int'l Conference on Standardization & Innovation in Information Technology (SIIT)

2007-10-18...19, Calgary, AB
<http://www.siiit2007.org>

Working Conference on Reverse Engineering (WCRE)

2007-10-28...31, Vancouver, BC
<http://www.rcost.unisannio.it/wcre2007/>

Working IEEE/IFIP Conference on Software Architecture (WICSA)

2008-02-18...21, Vancouver, BC
<http://www.computer.org/portal/pages/ieeecs/conferences/calendar.html>

Int'l Symposium on Advanced Control of Industrial Processes (Adconip)

2008-05-04...06, Jasper, AB
<http://www.adconip2008.org>

IEEE Instrumentation & Measurement Technology Conference (IMTC)

2008-05-12...15, Victoria, BC
<http://ewh.ieee.org/soc/im/imnew/>

IEEE Int'l Symposium on Electrical Insulation (ISEI)

2008-06-09...12, Vancouver, BC
<http://www.deis.nrc.ca/calendar.htm#2008>

14th Symposium on Electromagnetic Launch Technology (EML)

2008-06-10...13, Vancouver, BC
<http://www.emlsymposium.org>

30th Annual Int'l Conference of the IEEE Engineering in Medicine and Biology Society (EMBS)

2008-08-20...25, Vancouver, BC
<http://www.eng.unsw.edu.au/embs/>

IEEE Vehicular Technology Fall Conference (VTC)

2008-09-21...24, Calgary, AB
<http://www.vtc2008fall.org>

CENTRE ...

21st IEEE Canadian Conference on Electrical and Computer Engineering (CCECE-CCGEI)

2008-05-04...07, Niagara Falls, ON
<http://www.ewh.ieee.org/reg/7/ccece08/>

IEEE Int'l Symposium on Information Theory (ISIT)

2008-07-06...11, Toronto, ON
<http://www.isit2008.org>